

NJ State Contract!

SPECTRUM
Aquatics®
A PLAYCORE Company

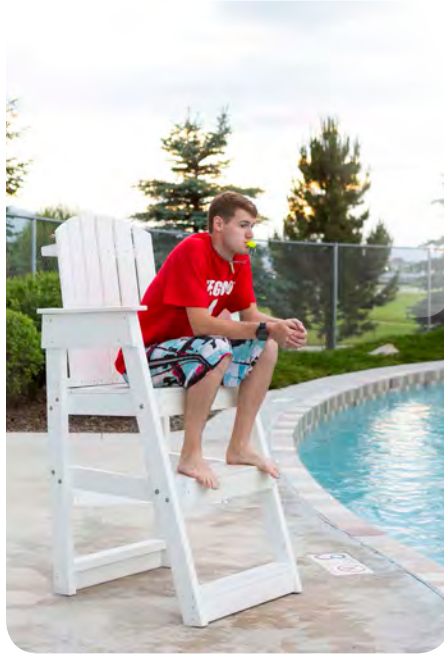

BEN SHAFFER
Recreation Inc.



PARK, PLAYGROUND & STREETScape SOLUTIONS

Serving NJ since 1921

P. O. Box 844
Lake Hopatcong, NJ 07849

1-800-953-2021

sales@benshaffer.com

www.benshaffer.com



4 STARTING PLATFORMS & COMPETITIVE SWIM

- 4 Overview
- 4 Backstroke Start Device
- 5 Single Post Starting Platforms
- 8 Dual Post Starting Platforms
- 9 Anchors & Covers
- 10 Racing Lane Lines - AntiWave & Competitor
- 11 Lane Line Storage & Competition Swim Products
- 11 Tot Dock Training Platform



12 POOL LIFTS & ACCESSIBILITY EQUIPMENT

- 12 ADA Overview
- 13 Why Spectrum Powered Lifts
- 14 Battery-Powered Lifts
- 15 Battery-Powered Lift Accessories
- 16 Water-Powered Lifts
- 17 Water-Powered Lift Accessories
- 17 Additional Accessibility Equipment



18 THEMED POOL PRODUCT LINES

- 18 Solarian™
- 19 Eleganté™

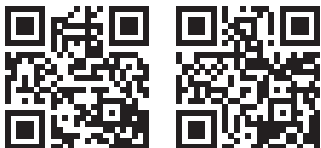

20 RAILS & LADDERS

- 20 Overview
- 20 Hand Rails
- 21 Custom Rails
- 22 Grab Rails
- 23 Ladders & Steps



24 DIVING STANDS & BOARDS

- 24 Dive Stands
- 25 Diving Boards



26 LIFEGUARD CHAIRS

- 27 Permanent Chairs
- 28 Moveable Chairs
- 29 Guard Chair Accessories



30 WATER SPORTS, GAMES & WATER PLAY

- 30 Pool Slides
- 32 Water Polo Goals
- 33 Basketball Hoops
- 33 Therapy Body Trainer



34 THERMAL POOL BLANKETS

- 34 Overview
- 34 Blanket Features
- 36 Blanket Storage Systems



38 ANCHORS & PARTS



42 CLEANING & MAINTENANCE

- 42 Vacuums, Filtration Systems & Pumps
- 43 Spectra-Clean™ Stainless Steel Maintenance



44 ABOUT US

- 44 Sales Terms & Conditions
- 45 Warranty
- 47 About Spectrum & PlayCore®
- 48 Measuring Guide

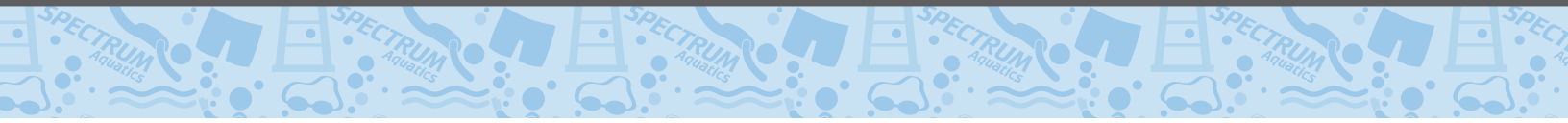

BACKSTROKE START DEVICES, STARTING PLATFORMS & COMPETITIVE SWIM

Spectrum Aquatics® line of single and dual post competitive starting platforms gives athletes the solid start needed to achieve better times and win races. Every frame we make is constructed of high quality US stainless steel, but what really sets our blocks apart from our competitors is the superior nonslip surface. Our stainless steel Record Breaker and Xcellerator block tops are coated with a grit overlay that provides a level of traction not available in competing products. Our plastic block tops, which are made of low density polyethylene, contain a superior, treaded surface that surpasses industry standards. Our single post anchoring system features a unique heavy duty bronze anchor with a patented anti-wobble, locator pin design. This enables easy installation and removal of starting blocks with no tools required. Spectrum Aquatics' blocks can accommodate nearly any deck and gutter configuration for both recreational and competition pools and can be manufactured to fit into existing anchors. Spectrum Aquatics platforms conform to FINA, USA Swimming, NCAA and NFHS rulings.

Our interest in swimming does not end with starting blocks. We have worked with numerous renowned backstroke medalists, as well as our colleagues at Colorado Time Systems, to develop a product aimed at reducing slip starts. The Backstroke Start Device is the result of this effort, and more info on this product is available below. Please call for pricing on this or other Spectrum products.

BACKSTROKE START DEVICE FROM SPECTRUM AQUATICS

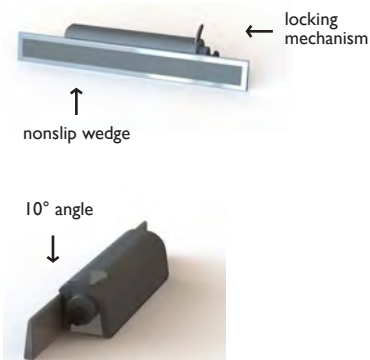

product demonstration video

Backstroke swimmers routinely risk a slip start when pushing off a pool wall or slippery touchpad during the start of a backstroke race. The backstroke start device (patent pending) from Spectrum Aquatics is designed to reduce slipping.

- Features a 65 x 8cm (25.6 x 3.1") nonslip wedge with a 10° angle to secure foot placement along pool wall
- Easily adjustable and locks into place, allowing swimmers to select desired location of the nonslip wedge along the pool wall
- Automatically retracts up and out of the water so as not to interfere with flip turns and touchpad interactions, eliminating the need for manual removal
- Compatible with nearly all block types and pool configurations - it can be strapped around a starting platform for easy set up, or attached to pop-up anchors in a pool deck for a more permanent (yet still removable) solution
- Custom attachment options are also available

HOW IT WORKS

1 Unlock and pull wedge strip to desired location

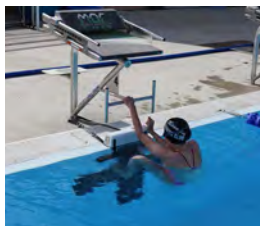

2 Place feet on nonslip wedge

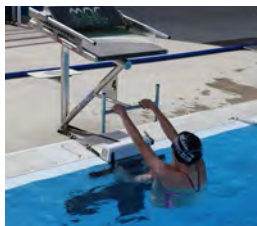

3 Proceed with your backstroke start



4 Wedge automatically retracts out of the water

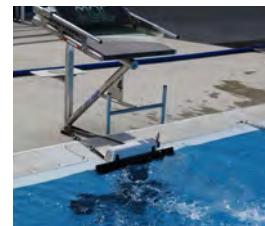

- I43081 BACKSTROKE START DEVICE WITH STRAP
- I43061 POP - UP ANCHOR
- I43062 CUSTOM ATTACHMENT

SINGLE POST STARTING PLATFORMS

XCELLERATOR®

Applying the latest in approved technology, this starting platform gives swimmers an extra boost on starts by allowing the rear leg to start at a 90° angle.



57282 XCELLERATOR – SINGLE POST

- Large 32" x 24" stainless steel top sloped at a 10° angle for optimal starting stances
- Covered in a superior non-slip material
- Easy-to-adjust track start footrest attachment with 12 setting options to accommodate all heights and levels of flexibility
- Uses single post anchor with patented anti-wobble design allowing for easy removal
- Side handles included to enhance speed and quick takeoffs
- Non-slip side access step
- Backstroke handles with versatile 18" H bar
- Stainless steel construction
- Suggested setback of 30" – accommodates anchor setbacks of 24" to 38"
- Available in black, with upgrade of custom colors and logos available
- Easy-to-read, large numbers
- Complies to FINA, USA Swimming, NCAA and NFHS regulations

RECORD BREAKER



57283 RECORD BREAKER – SINGLE POST

- Large 32" x 24" stainless steel top sloped at a 10° angle for optimal starting stances
- Covered in a superior non-slip material
- Easily upgradable to Xcellerator with the addition of the side handles & track start footrest
- Uses single post anchor with patented anti-wobble design allowing for easy removal
- Non-slip access step, available on side or rear
- Side step accommodates anchor setbacks of 18" to 38"
- Rear step accommodates anchor setbacks of 30" to 38"
- Backstroke handles with versatile 18" H bar
- Stainless steel construction
- Easy-to-read, large numbers
- Available in black, with upgrade of custom colors and logos available
- Complies to FINA, USA Swimming, NCAA and NFHS regulations

SINGLE POST ANCHOR

This unique, patented anti-wobble and locator pinned design is superior to all other single-set type anchors. There is no known equal.

21700 SINGLE POST ANCHOR
21705 ANCHOR SET TOOL

- No tools required when installing or removing starting platform
- Machined bronze ensures extremely tight tolerances & offers superior corrosion resistance
- Locating slot design eliminates rotation and guarantees proper alignment of platform
- Includes stainless steel lid and removal tool

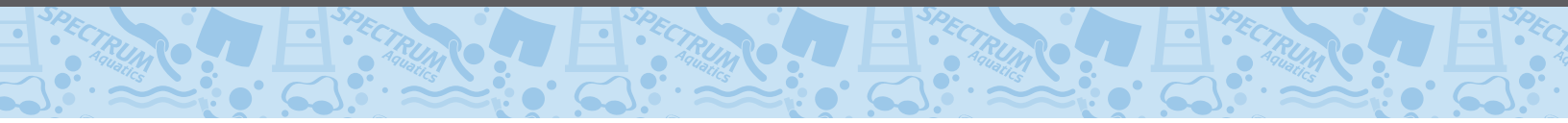

TIME INTEGRATED STARTING PLATFORMS

FUSION STARTING PLATFORM

The Fusion Starting Platform is a fusion of technologies between Spectrum Aquatics® and Colorado Time Systems®. The block features a CTS Relay Judging platform and accessories, as well as an adjustable Track Start footrest as approved by FINA, USA Swimming, NCAA and NFHS compliant.

- Built-in Colorado Time System® RJP to calculate reaction time and relay exchanges
 - Speedlights across the front of the RJP and step-side start indicator flash simultaneously with starting system horn and strobe light
 - Lights provide an additional signal to athletes and create a more equal start for hearing-impaired swimmers
 - Easy, out-of-the-way plug-ins for RJP touchpad, speedlights, lane speaker and back-up buttons
- FINA, NFHS, USA Swimming and NCAA compliant
- Uses single post anchor with patented anti-wobble, locator pinned design
- 32" x 24" NON-SLIP surface platform top for extra-fast starts
- Side handles to enhance speed and quick takeoffs
- Backstroke handles with versatile 18" H bar
- Stainless steel construction
- Suggested setback of 30" – accommodates anchor setbacks of 24" to 38"
- Available in grey, with upgrade of custom colors and logos available



57281 FUSION

INTEGRATION WITH OTHER MAJOR TIMING COMPANIES AVAILABLE



STARTING PLATFORMS & COMPETITIVE SWIM



GROWLER, GRIZZLY AND QUICKSILVER STARTING PLATFORMS OFFER:

- Exclusive locating slot design eliminates rotation and guarantees proper fit and alignment of platform
- Constructed of low density polyethylene material resistant to chemicals with UV inhibitors to resist discoloration, fading and cracking
- Single post machine bronzed anchor equipped with a stainless steel lid assembly
- Front hand and toe grip for faster takeoffs
- Backstroke handles with versatile 18" H bar
- Easy to install and remove, with no tools required

AVAILABLE IN FIVE COLORS:



RED

BLUE

GREEN

YELLOW

WHITE

GROWLER

One of Spectrum's most popular starting platforms, the Growler is great for all levels of competition and features the largest top in the industry.



21653 GROWLER – SIDE STEP
21657 GROWLER – REAR STEP

- Large 32" x 25" single piece LDPE platform with molded-in, non-slip surface - no exposed bolts or hardware
- 10" x 8" access step with molded-in, non-slip surface available in side or rear
- Side step accommodates anchor setbacks of 18" to 40"
- Rear step accommodates anchor setbacks of 30" to 40"
- Easy-to-read, large numbers
- Complies to FINA, USA Swimming, NCAA and NFHS regulations

GRIZZLY

Another one of Spectrum's most popular starting platforms. Great for all levels of competition.



21654 GRIZZLY – SIDE STEP
21655 GRIZZLY – REAR STEP

- 23" x 25" single piece LDPE platform with molded-in, non-slip surface; no exposed bolt or hardware
- 10" x 8" LDPE side or rear access step with molded-in, non-slip surface
- Accommodates anchor setbacks of 20" to 30"
- Superior stability and performance
- Easy-to-read, large numbers
- Complies to FINA, USA Swimming, NCAA and NFHS regulations

QUICKSILVER

Ideal for beginners and pools with large water drafts.



57289 QUICKSILVER

- 23" x 25" non-slip surface with no exposed bolts or hardware
- Front hand and toe grip for faster takeoffs
- Horizontal backstroke bar
- Stainless steel construction
- Suggested setback of 20" -- accommodates setbacks of 12" to 24"
- Does NOT meet FINA, USA Swimming, NCAA or NFHS Guidelines



DUAL POST STARTING PLATFORMS

Just like our single post platforms, dual post starting platforms from Spectrum Aquatics include incredible non-slip tops and steps. Our stainless steel block tops are coated with a grit overlay that provides a level of long-lasting traction not available in competing products. Our plastic tops are made of low density polyethylene and contain a non-slip surface that surpasses industry standards. These tops are a great choice for facilities that remove and store the blocks a lot – they can take a beating. Our plastic tops also stand up to strong pool chemicals and resist discoloration, fading and cracking.

- Front hand and toe grip for faster takeoffs
- 20" wide competition-width backstroke bar
- Easy to install and remove without tools
- Electropolished and SpectraShield treated stainless steel construction provides high-quality finish that resists corrosion
- Anchors and covers sold separately
- Easy-to-read, large lane numbers
- All of our dual post blocks comply to FINA, USA Swimming, NCAA and NFHS regulations



BIGHORN



A starting block for wide gutter and parapet designs used in many competition and recreational pools.

- 23" x 25" non-slip surface with no exposed bolts or hardware
- 20" molded-in, non-slip surface step tread
- Standard Bighorn accommodates anchor setbacks of 20" to 30"
- Longreach accommodates an anchor setback of up to 40"
- Anchors sold separately

21095 BIGHORN
21115 BIGHORN LONGREACH

COUGAR



A starting block designed for top-notch competition & recreational pools with swim teams.

- 32" x 25" non-slip surface - LARGEST PLATFORM TOP IN THE INDUSTRY
- Easy-to-read, large numbers
- Sleek platform top and step treads with no exposed bolts or hardware
- Available with side & rear step
- Cougar side step accommodates anchor setbacks of 18" to 29"
- Cougar rear step accommodates anchor setbacks of 30" to 40"

21135 COUGAR – SIDE STEP
21145 COUGAR – REAR STEP

XCELLERATOR



- Large 32" x 24" stainless non-slip steel top sloped at a 10° angle for optimal starting stances
- Adjustable track start footrest attachment with 12 setting options
- Side handles and 18" backstroke U Bar included to enhance speed and quick takeoffs
- Non-slip side access step available
- Suggested setback of 30" – accommodates anchor setbacks of 24" to 38"
- Available in black, with upgrade of custom colors and logos available
- Complies to FINA, USA Swimming, NCAA and NFHS regulations

133171 XCELLERATOR – DUAL POST

RECORD BREAKER



- Large 32" x 24" stainless steel non-slip top sloped at a 10° angle for optimal starting stances
- Easily upgradable to Xcellerator with the addition of the side handles & track start footrest
- Non-slip access step, available on side or rear
- Side step accommodates anchor setbacks of 18" to 38", Rear step anchor setbacks: 30" to 38"
- Backstroke handles with versatile 18" U bar
- Available in black, with upgrade of custom colors and logos available
- Complies to FINA, USA Swimming, NCAA and NFHS regulations

57741 RECORD BREAKER – DUAL POST

DUAL POST ANCHOR ASSEMBLIES

Designed for use with all dual post starting blocks designs. The welded fixture design and center-to-center anchor placement makes installation and removal easy.



- Fabricated of 304L stainless steel
- Includes bonding lug, caps and removal key
- Tamper-resistant lids
- Available in 6" and 10" deep options

24070 6" DEEP DUAL POST ANCHOR SET
24071 10" DEEP DUAL POST ANCHOR SET

STARTING PLATFORM SOFT COVER

Help prevent unauthorized use of starting blocks with our soft covers. Made for use in both indoor and outdoor aquatic environments.



- UV rated polyethylene material with draw cord
- Universal fit covers all platforms up to 32" x 25" in size

21400 STARTING PLATFORM SOFT COVER

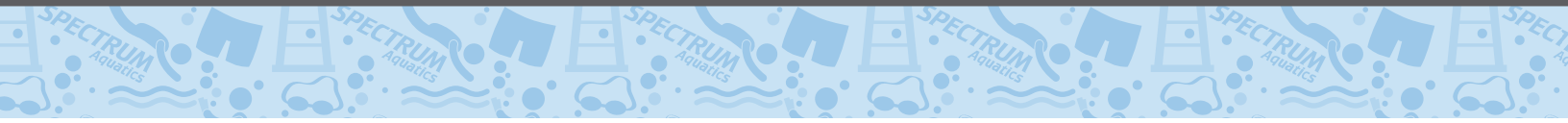

RACING LANE LINES

ANTI-WAVE LANE LINES



ANTI-WAVE FORERUNNER 4.75" LANE LINE

Designed to deflect wave motions downward through hydrodynamic propulsion for wake free competitive swimming. Durable, injection-molded polyethylene discs with built-in UV and chemical resistors. Ships assembled and complete with an "S" hook on one end and a Supertensioner™ on the other. All hardware is made of stainless steel and plastic. Water polo boundary and goal tethers available.

SPECIFY COLORS WHEN ORDERING:

Blue	Red	Green	Yellow
Orange	Navy	Teal	Grey
Purple	Dark Blue	White	Black
Pink	North Carolina Blue	Metallic Silver	Metallic Gold
Maroon			

4.75" FORERUNNER LANE LINES:

- 55810 60 FT LINE
- 55815 75 FT LINE
- 55820 25M LINE
- 55825 50M LINE
- 55830 50M LINE WITH 1 DISCONNECT
- 55835 50M LINE WITH 2 DISCONNECTS
- 55840 CUSTOM LENGTH BY FOOT

6" MAXIMUM LANE LINES:

- 55850 60 FT LINE
- 55855 75 FT LINE
- 55860 25M LINE
- 55865 50M LINE
- 55870 50M LINE WITH 1 DISCONNECT
- 55875 50M LINE WITH 2 DISCONNECTS
- 55880 CUSTOM LENGTH BY FOOT

COMPETITOR LANE LINES



COMPETITOR 4" LANE LINE

Patented flow-through design controls water turbulence by allowing wave energy to be dispersed along the length of the lane. Consists of a series of polyethylene disks and donuts that rotate independently, allowing wave energy to be absorbed and dispersed within the channel of the lane, optimizing conditions for training and competition. Ships fully assembled.

LARGE & SMALL DISK COLOR OPTIONS



COMPETITOR 4" DESIGN:

- 55020 60 FT LINE
- 55040 75 FT LINE
- 55060 25M LINE
- 55080 50M LINE
- 55100 25M DISC TO 1-75' LANE
- 55120 50M DISC TO 2-75' LANE
- 55140 50M DISC TO 1-75' LANE
- 55160 50M DISC TO 1-75' LANE AND 1-25M LANE
- 55170 4" CUSTOM LANE LINES (PER FOOT)
- 55180 HARDWARE KIT FOR CUSTOM LINES

COMPETITOR GOLD MEDAL 6" DESIGN:

- 55220 60 FT LINE
- 55240 75 FT LINE
- 55260 25M LINE
- 55280 50M LINE
- 55300 25M DISC TO 1-75' LANE
- 55320 50M DISC TO 2-75' LANE
- 55340 50M DISC TO 1-75' LANE AND 1-25M LANE
- 55290 6" CUSTOM LANE LINES (PER FOOT)



LANE LINE STORAGE & COMPETITIVE SWIM PRODUCTS

SHERIDAN LANE LINE STORAGE REEL



Unique stainless steel construction with locking casters

- 304L stainless steel construction
- Passivated for maximum corrosion resistance
- Capacity: 720' of 4" line or 400' of 6" line
- 4" 304L stainless steel caster wheels with locking brakes
- 6' 5 7/8" (L) x 5' 5/64" (W) x 5' 6 11/16" (H)

55525 SHERIDAN STORAGE REEL
55552 SHERIDAN REEL COVER

STAINLESS STEEL CUP ANCHORS



Used for securing lane lines and safety ropes in concrete and gunite pools. Kit includes bonding screw.

58316 4" SS CUP ANCHOR WITH REMOVABLE EYEBOLT
58280 3" ROUND WITH REMOVABLE EYEBOLT, CPB

STANCHION POSTS



Designed to support backstroke lines, finish lines, recall lines, volleyball nets and splash curtains. Flags not included. Made of 1.90" O.D. x .145" material. Available in 316 stainless steel upon request.

- 2" top ring for connection to backstroke flags or recall ropes
- Optional sliding collar available

23614 8' BACKSTROKE STANCHION
23624 4'6" BACKSTROKE STANCHION
23625 1.90" O.D. SLIDING RING
23638 BRONZE 6" STANCHION ANCHOR KIT – INCLUDES LID AND KEY
24060 STAINLESS STEEL ANCHOR KIT – INCLUDES CAP AND KEY

TOT DOCK TRAINING PLATFORM



This training platform is an excellent teaching aid which helps beginning swimmers feel at ease and secure during lessons by decreasing water depth and offering grab rails.

- Freestanding and easily placed into the shallow area of the pool
- Adjustable, weighted legs
- Stainless steel frame
- 42"x60" non-slip platform made of UV stabilized structural fiberglass
- Multiple units can be configured together
- Includes protective rubber bumpers

82300 TOT DOCK



POOL LIFTS & ASSISTED ACCESS

Enabling equal access to aquatic facilities has always been a goal of Spectrum Aquatics®. We were proud to release our first aquatic lift in 1974 and after 40 years of refinement and technological advancement, we now offer 20 different pool lift options. Choose between manually-powered, battery-powered and water-powered lifts – all with proprietary, robust operating systems. Our lifts offer ease of transfer while maintaining an open deck area. Our battery-powered units offer 90 lifts per battery charge and all our lifts are 100% stainless steel, electropolished and passivated construction. Our lifts deliver optimal performance and withstand harsh aquatic environments — indoors and out.



ADA COMPLIANCE OVERVIEW

In 2010, the federal government approved into law the 2010 ADA Standards, requiring all commercial pools to have an ADA-approved means of access by March 15, 2012. Compliance was later extended until January 31, 2013 and requires pools to install a ramp or a pool lift. A lift from Spectrum Aquatics® can help you achieve compliance.

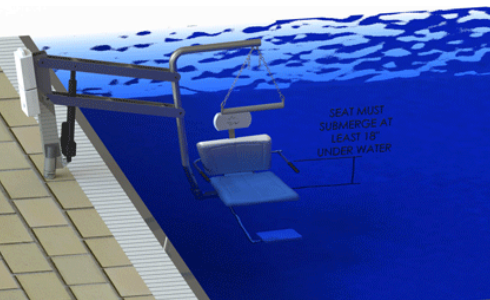

WHAT MAKES A POOL LIFT COMPLIANT

REQUIRED LIFT FEATURES

- 300 lbs minimum weight capacity
- Capable of unassisted operation from deck and water
- Solid seat at least 16" wide
- Armrests are optional (except in California), but if included must be removable or fold clear of the seat
- Footrest (not required with lifts used in spas)
- Capable of lowering the seat to a minimum depth of 18" below the stationary water level

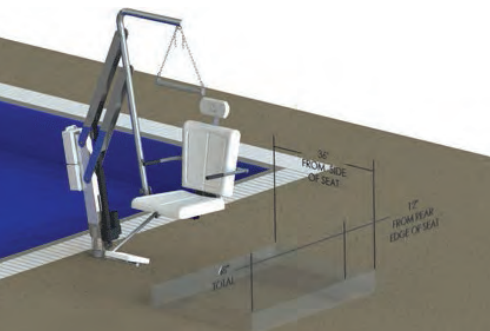

LIFT LOCATION SPECIFICATIONS

- Located in less than 48" of water
- Seat centerline location must be a minimum of 16" from the edge of the pool in raised position
- Open deck space minimum of 36" wide that extends forward a minimum of 48" from a line located 12" behind the rear of the seat located on opposite side of the seat from the water
- Must be level, with a slope no greater than 1:48 (2%) in all directions

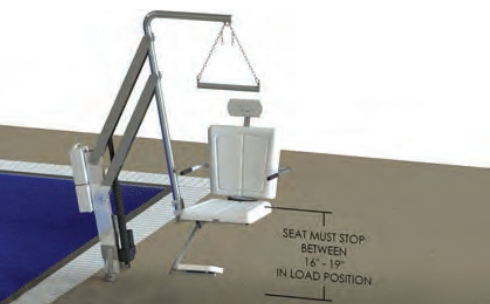

LIFT OPERATION SPECIFICATIONS

- Seat Height - Lift should allow for a stop between 16" and 19" above the top of the deck when in the raised position
- The controls and operating mechanisms should be unobstructed when the lift is in use
- Operation of the lift should not require tight grasping, pinching or twisting of the wrists to operate



WHY SPECTRUM POWERED LIFTS

QUALITY & DURABILITY

- NSF certified for ADA Compliance
- All stainless steel construction
- Metal housing materials for battery powered delivery & heavy duty performance
- Triple protected for maximum corrosion resistance in harsh pool environments
 - Manufactured from non-recycled U.S. stainless steel for minimal impurities and maximum corrosion protection
 - Electropolished and passivated
 - Coated with SpectraShield®

PERFORMANCE

- Thermally-protected with an internal heat sensing switch that prevents damage if the actuator becomes overheated or overloaded
 - Avoids substantial repairs, labor costs and lift downtime
 - No other lift manufacturer offers this feature to prevent system failure
- Completely sealed waterproof battery
- Battery delivers 90 lifts between charges - no other lift manufacturer compares
- 300-500 lb. load capacity depending on model
- Rotationally & vertically powered with 360° continuous power rotation
- Stabilizer bar improves lift stability (only available with Traveler 500)
- Heavy-duty Actuator System

VERSATILITY

- Works with a broad range of deck configurations
- Spectrum lift line offers setbacks ranging from 6" to 40" and a water draft up to 12"
- Allows loading and unloading from any desired position or angle
- Small footprint ideal for limited deck space
- Completely wireless system (Battery only)
- Wheelchair and spine board attachments available for Traveler 500 only (See page 15)

CUSTOMER SERVICE

- Quality customer service
- Nationwide customer service, engineering and technical support
- Quick turn-around times

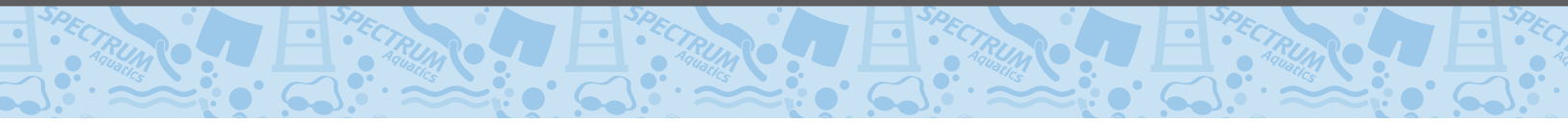

BATTERY-POWERED LIFT BENEFITS

- Certified ADA Compliant by NSF International
- Minimum 300 lb lifting capacity
- Powered by 24V rechargeable battery
- 90+ lifts per battery charge
- Self-operable from deck and water with waterproof remote control
- 360° continuous rotation in either direction
- Made from all stainless steel construction (304L Grade)
- Coated with SpectraShield® for maximum corrosion protection
- Stabilizer bar improves lift stability
- Spacious seat
- Designed for ease of transfer
- Quiet and stable operations
- Designed for in-ground and above-ground pools and spas
- Proprietary, robust Operating System & Actuator outperform other lifts
- All models come standard with:
 - Battery & battery charger
 - Waterproof wireless, floatable remote control technology
 - Foot rest
 - Seat belt assembly
 - Arm rest



FREEDOM LIFT

- 350 lb. lifting capacity
- One watertight remote control
- Anchor included
- Composite anchor
- Foot rest
- One removable arm rest
- Accommodates setback of 6" to 22" and water draft up to 12"

57961 FREEDOM LIFT
28510 ANCHOR KIT

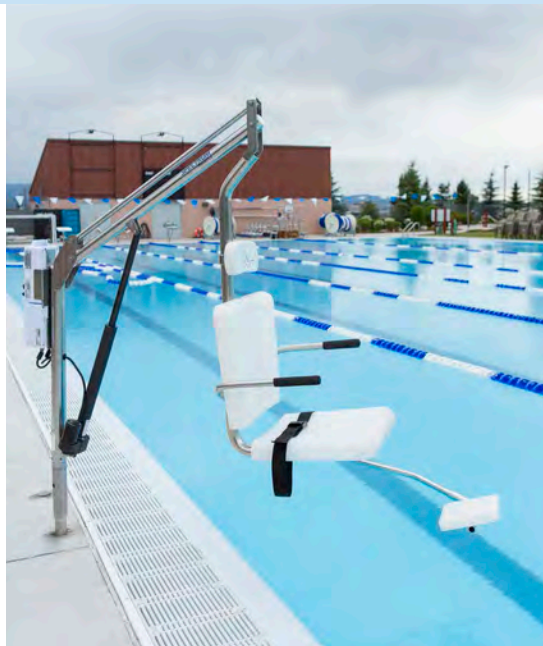

ASPEN LIFT

- 350 lb lifting capacity
- Two watertight remote controls
- Adjustable swing-out footrest for ease of transfer
- Removable arm rest with non-slip grip for safety and comfort
- Padded head rest
- Accommodates setback of 6" to 22" and water draft up to 12"

26010 ASPEN LIFT
28510 ANCHOR KIT

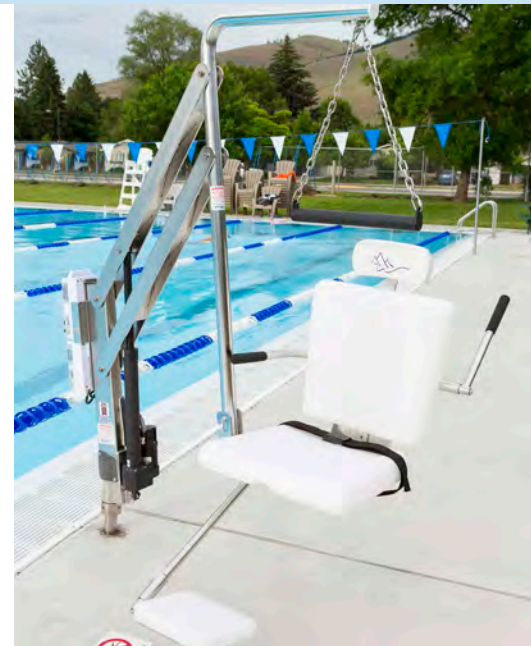

TRAVELER LIFT

- 500 lb lifting capacity
- Two watertight remote controls
- Adjustable swing-out footrest for ease of transfer
- Flip up arm rest with non-slip grip for safety and comfort
- Adjustable padded head rest
- Custom spineboard and wheelchair attachments available
- Accommodates setback of 6" to 33" and water draft up to 12"

27610 TRAVELER LIFT
23638 TRAVELER ANCHOR KIT

BATTERY-POWERED POOL LIFT ACCESSORIES



REMOTE CONTROL



FACILITY SIGN



BATTERY



SPECTRA-CLEAN™



POOL COVER



BACK BOARD

POOL LIFT PARTS & ACCESSORIES

- 28510 ASPEN/FREEDOM ANCHOR
- 28515 WOOD DECK ANCHOR
- 75521 SURFACE MOUNT ANCHOR
- 28550 ANCHOR ADAPTOR - 2 3/8" TO 1.90" ID ANCHOR
- 42932 WHEELCHAIR FOR TRAVELER
- 54377 TRAVELER COVER

- 47949 FREEDOM & ASPEN LIFT COVER
- 61839 PORTABLE LIFT COVER
- 42257 REMOTE
- 143007 BATTERY - WIRED
- 42693 BATTERY - TABBED
- 42732 BATTERY CHARGER
- 133036 RECEIVER - WIRED

- 54495 RECEIVER - TABBED
- 42323 BACK BOARD (TRAVELER ONLY)
- 132038 ARMS
- 42644 ADA COMPLIANT LIFT AVAILABLE SIGN
- 47906 SPECTRA-CLEAN™ STAINLESS STEEL CLEANER



PORTABLE FREEDOM LIFT

- 300 lb lifting capacity
- One watertight remote control
- Battery and battery charger
- Foot rest
- One arm rest

- 42618 PORTABLE FREEDOM LIFT
- 42672 ADA LOCKDOWN KIT

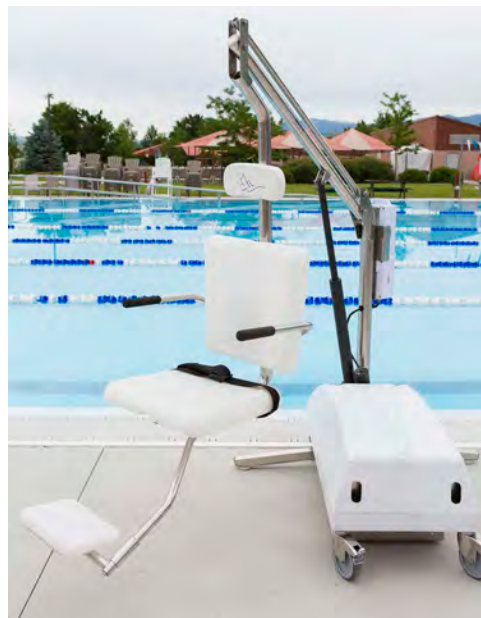

PORTABLE ASPEN LIFT

- 300 lb lifting capacity
- Two watertight remote controls
- Adjustable swing-out footrest for ease of transfer
- Arm rest with non-slip grip for safety and comfort
- Padded head rest

- 42643 PORTABLE ASPEN LIFT
- 42672 ADA LOCKDOWN KIT



SUMMIT THERAPY LIFT

- 500 lb lifting capacity
- Two watertight remote controls
- Capable of traveling over a wall Aheight of 64" and width of 24"
- Designed for therapy and above-ground spas

- 57295 SUMMIT LIFT 500BP
- 57288 SUMMIT ANCHOR KIT 500

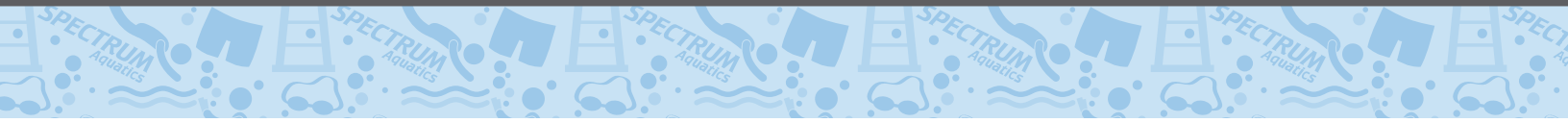

WATER-POWERED LIFT BENEFITS

- ADA and Title 24 Compliant
- Minimum 400 lb lifting capacity
- Powered by large diameter cylinder and piston for faster and more powerful lifting capacity
- Made from all stainless steel construction (304L Grade)
- Coated with SpectraShield® for maximum corrosion protection
- Spacious seat
- Designed for ease of transport with built-in wheels for portability
- Spectra Force Pressure Booster System
- Runs on standard 55 psi water pressure
- Quiet and stable operations
- Designed for in-ground and above-ground pools and spas
- Base stand design that accommodates high loading capacity with minimal deflection
- All models come standard with:
 - Foot rest
 - Padded head rest
 - Seat belt assembly
 - Unit mounted control lever



GALLATIN

- Flexibility allows for use in swimming pools and spas
- Minimum deck to pool bottom depth of 12"
- Wheels for portability
- Accommodates setback of 18" to 30" and water draft up to 12"

27336 GALLATIN LIFT



LOLO

- Minimum deck to pool bottom depth of 42"
- Pool applications only
- Wheels for portability
- Accommodates setback of 18" to 30" and water draft up to 12"

27550 LOLO LIFT



GREYCLIFF

- Institutional grade lift for in-ground pools
- Optional stretcher, stretcher wheel carriage and wheelchair attachments available
- 500 lb lifting capacity
- Manual rotation does not meet ADA standards

26105 GREYCLIFF LIFT MANUAL
 26120 GREYCLIFF LIFT AUTO ROTATE
 26110 ANCHOR GREYCLIFF PRESET
 26111 ANCHOR GREYCLIFF RETRO

WATER-POWERED POOL LIFT ACCESSORIES

- 27028 SPECTRA-FORCE PRESSURE BOOSTER SYSTEM**
- Generates water pressure for lifts – 55 psi recommended operating pressure
 - Floor or wall mounted
 - Consists of ½ HP stainless steel centrifugal pump, hydropneumatic pressure-sustaining tank, adjustable pressure switch, liquid filled pressure gauge, bronze check valve, fittings and all necessary tubing connectors

- 25186 SPROTECTIVE COVER**
- Protect your swim lift with an indoor/outdoor polyethylene cover
 - Easy to deploy and folds up easy for storage

ANCHORS

- 27400** GALLATIN/LOLO RETRO-FIT ANCHOR
- 27450** GALLATIN/LOLO PRESET ANCHOR
- 20400** WATER BOX
- 54372** ATTACHMENT FOR RIM FLOW GUTTERS

ADDITIONAL ACCESSIBILITY EQUIPMENT



ELKHORN

Manual-powered lift. Single lever hydraulic arm raises and lowers the occupant into and out of the water.

- Frictionless unit
- 400 lb lifting capacity
- Hydraulic ram lifting mechanism
- Portable and lightweight, weighing less than 60 pounds
- Single anchor point
- Easy to operate and install
- Great for residential applications
- Does not meet ADA standards

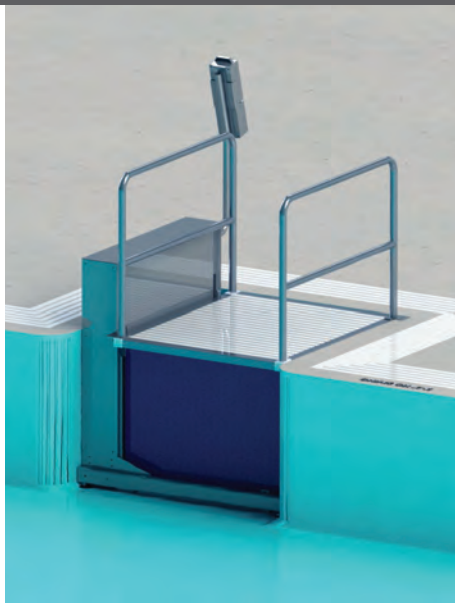

GLACIER PLATFORM LIFT

Vertical travel platform to accommodate mobility devices and the need for assisted stabilized support.

- Large 46" x 40" platform
- 600 lb lifting capacity
- Travels up to 48 vertical inches
- Safety gates provided standard
- Patent pending



ACCESS RAMP

Provides quick and easy access. Wheels allow for removal for competitive activities. Mounting hardware included.

- Supports 400 lb loads
- 15' ramp length
- 36" wide structural fiberglass T-Bar slip-resistant surface
- Custom fabricated to ensure proper fit with your pool
- Can be customized to meet ADA compliance standards

- 28500** ELKHORN
- 28510** ANCHOR KIT - ELKHORN

- 26400** GLACIER PLATFORM LIFT WP600 (WATER POWERED)
- 42700** GLACIER PLATFORM LIFT BP600 (WATER POWERED)

- 28630** ACCESS RAMP

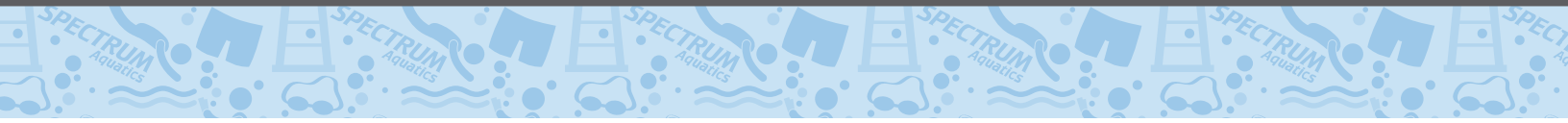

THE SOLARIAN™

Add style and elegance to your pool without sacrificing functionality or safety with the Solarian, a designer line of themed pool deck equipment. Ladders, rails, lifeguard chairs, diving boards and pool blanket winders are all designed to give your pool an updated, harmonized look. Our products are made of 304L (or 316L upon request) US stainless steel, electropolished and passivated with Spectra Shield™ for maximum corrosion resistance. Powder coating options available. Products can be purchased in any combination as well as individually. This unique product line is offered in 1.5" diameter & 1.9" diameter railing.

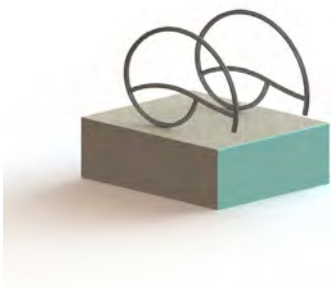

144018 SOLARIAN GRAB RAIL (2 EA)



134886-48 SOLARIAN STAIR RAIL 48"
134886-60 SOLARIAN STAIR RAIL 60"
134886-72 SOLARIAN STAIR RAIL 72"

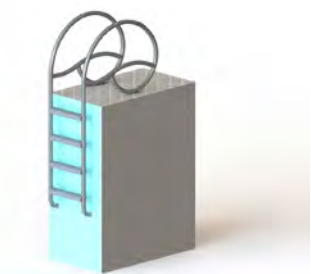

134640-02-.065 2 STEP SOLARIAN 30" LADDER
134640-03-.065 3 STEP SOLARIAN 30" LADDER
134640-04-.065 4 STEP SOLARIAN 30" LADDER



144027-4 SOLARIAN 4' PERMANENT LIFEGUARD CHAIR
144027-6 SOLARIAN 6' PERMANENT LIFEGUARD CHAIR



144098-4 SOLARIAN 4' PORTABLE LIFEGUARD CHAIR
144098-6 SOLARIAN 6' PORTABLE LIFEGUARD CHAIR

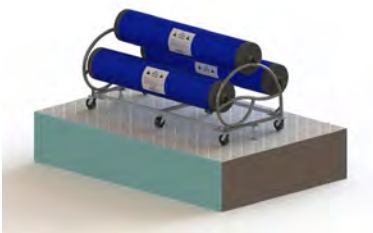

144043-1 SOLARIAN SINGLE BLANKET WINDER
144043-2 SOLARIAN DOUBLE BLANKET WINDER
144043-3 SOLARIAN TRIPLE BLANKET WINDER

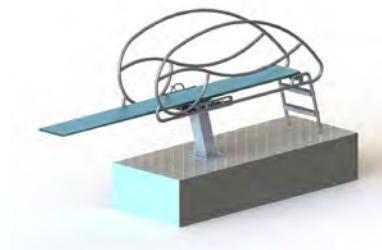

144088 SOLARIAN IM DIVE STAND

ELEGANTE'™

The Elegante' line of rail products from Spectrum Aquatics is the perfect excuse to add “curve” appeal to your commercial or residential pool project. The circular shape brings a classic elegance to your pool aesthetics in a manner that promotes function and safety. Ladders, hand and grab rails are available in 304L US stainless steel in 1.5 x .083 and 1.9 x .065 tubing sizes. Other options are available upon request.



149295-083 ELEGANTE' GRAB RAIL 1.5 X .083 (2 EA)
 149296-065 ELEGANTE' GRAB RAIL 1.9 X .065 (2 EA)



149220-48-083 48" ELEGANTE' STAIR RAIL 1.5 X .083
 149220-60-083 60" ELEGANTE' STAIR RAIL 1.5 X .083
 149220-72-083 72" ELEGANTE' STAIR RAIL 1.5 X .083
 149222-48-065 48" ELEGANTE' STAIR RAIL 1.9 X .065
 149222-60-065 60" ELEGANTE' STAIR RAIL 1.9 X .065
 149222-72-065 72" ELEGANTE' STAIR RAIL 1.9 X .065



149316-02-083 2 STEP ELEGANTE' LADDER 1.5 X .083
 149316-03-083 3 STEP ELEGANTE' LADDER 1.5 X .083
 149316-04-083 4 STEP ELEGANTE' LADDER 1.5 X .083
 149367-02-065 2 STEP ELEGANTE' LADDER 1.9 X .065
 149367-03-065 3 STEP ELEGANTE' LADDER 1.9 X .065
 149367-04-065 4 STEP ELEGANTE' LADDER 1.9 X .065

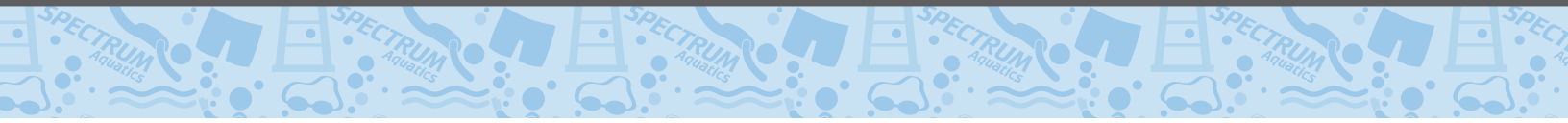

RAILS & LADDERS

Spectrum Aquatics' standard rail goods are available in various lengths, shapes, wall thicknesses and diameters. All rails and ladders are passivated in an environmentally-friendly citric acid solution that provides a uniform and highly corrosion resistant finish that is further protected by SpectraShield®.

Spectrum's standard rails comply with the 2010 ADA Standards for Accessible Design and provide the best possible gripping surface for the user. Anchors & escutcheons are sold separately.

WHY CHOOSE SPECTRUM RAILS?

- High-quality, 100% stainless steel rails are elegant & unique in design. Durable and easy to maintain
- Rails are available in a myriad of shapes and sizes with a variety of outside diameters and wall thicknesses
- Standard rails meet ADA requirements

MATERIAL TYPE & GRADE AVAILABLE:

- 304L - Stainless Steel
- 316L - Marine Grade Stainless Steel
- Powder Coat – Available in all RAL colors & a variety of finishes
- Variety of outside diameters and wall thicknesses

HAND RAILS

KOKANEE



Stair rail for applications with automatic pool covers.

- 35005 48" KOKANEE
- 35007 60" KOKANEE

VARDEN



This long reach stair rail allows for on-deck anchoring. No in-pool anchor is required.

- 36246 48" VARDEN
- 36251 60" VARDEN

2 AND 3 BEND STAIR RAILS



Ideally suited for use on commercial swimming pool and spa applications.

- | | |
|-----------------------------|-----------------------------|
| 35125 48" 2 BEND STAIR RAIL | 35009 48" 3 BEND STAIR RAIL |
| 35126 60" 2 BEND STAIR RAIL | 35011 60" 3 BEND STAIR RAIL |
| 35127 72" 2 BEND STAIR RAIL | 35013 72" 3 BEND STAIR RAIL |

RECESSED MOLDED STEP

The recessed step is made from heavy-duty injection molded plastic with a non-skid surface. Unit is white but can be painted any color to match your décor.

23450 RECESSED MOLDED STEP



RECESSED STAINLESS STEEL STEP

Slip resistant and fabricated from 304L stainless steel with an all welded design. The 5"x15" opening provides a generous area for foot placement and is sandblasted for added safety.

23452 RECESSED STAINLESS STEEL STEP



CUSTOM RAILS

Spectrum Aquatics® specializes in crafting functional and beautiful custom railings. Rails are fabricated from a variety of stainless steel material types (304L and 316L) as well as a variety of outside diameters and wall thicknesses (1.25" x .065", 1.90" x .065", 1.50" x .083", 1.90"x.109", 1.50" x .120", 1.90"x.145"). All 1.25", 1.50" and 1.90" OD railings comply with the 2010 ADA Standards for Accessible Design.

FORM & FUNCTION

Spectrum Aquatics' in-house engineering and design team turns your ideas into reality. Our high-quality stainless steel and state-of-the-art manufacturing processes fabricate rails that fit your specifications.

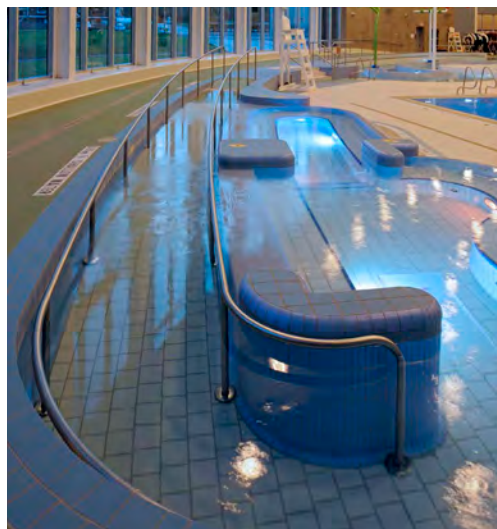

Made from 100% U.S. Made and Melted Stainless Steel

CUSTOM RAIL OPTIONS:

- Diving Tower Railings
- Guard Rails
- Grab Rails
- Hand Rails
- Therapy Rails
- In-Pool Exercise Rails
- Ramp Rails
- Stair Rails
- Stadium Rails
- Spectator/Crowd Control Rails



GRAB RAILS



COHO

The 26" Coho works best with commercial swimming pools with flat, level decks and standard copings and curbs. Accommodates a setback anchoring of 18" from the pool wall.

37150 26" COHO



BURBOT

The Burbot grab rails accommodate commercial pools with a longer setback. These long grab rails are ideally suited for use on swimming pools that utilize rollout or deck-level gutter design configurations.

35113 26" BURBOT

35110 30" BURBOT



CISCO

Cisco rails were designed for commercial swimming pools and are ideally suited for use on swimming pools that utilize skimmers or a typical gutter design configuration.

35117 17" CISCO

35121 26" CISCO

35124 30" CISCO



PIKE ADJUSTABLE RAIL

The Pike Adjustable Rail has front legs which provide for individual rail adaptability. Commonly used for pools which employ unusual curbs, gutters or trench drain configurations.

35099 26" PIKE ADJUSTABLE RAIL



GROUSE THERAPY RAIL

Therapy bar for pools, bathrooms, and showers. Designed to ADA standards with 1.25 or 1.50 O.D. material.

28702 16" GROUSE 1.25

28703 18" GROUSE 1.25

28704 24" GROUSE 1.25

28706 32" GROUSE 1.25

28708 48" GROUSE 1.25

28710 16" GROUSE 1.5

28711 18" GROUSE 1.5

28709 24" GROUSE 1.5

28712 32" GROUSE 1.5

28713 48" GROUSE 1.5



HERON THERAPY RAIL

Therapy bar which incorporates a mid-span anchor flange. Designed to ADA standards with 1.25 or 1.50 O.D. material.

28722 48" HERON 1.25

28724 60" HERON 1.25

28725 72" HERON 1.25

28226 96" HERON 1.25

28714 48" HERON 1.5

28715 60" HERON 1.5

28716 72" HERON 1.5

28717 96" HERON 1.5

LADDERS & STEPS

Spectrum's ladders come in a variety of sizes including 25", 27", 30" or 36" and are equipped with deluxe treads. The 20" wide HDPE tread incorporates molded nut inserts, eliminating the need for exterior nuts and sharp surfaces and is equipped with a step reference locator. Mounting anchors and escutcheons are sold separately. Customization is available for other sizes and setbacks.



STANDARD LADDERS

- 35129 2 STEP STANDARD LADDER
- 35131 3 STEP STANDARD LADDER
- 35133 4 STEP STANDARD LADDER
- 35135 5 STEP STANDARD LADDER

HEAVY-DUTY LADDERS WITH CROSS BRACE

- 36178 2 STEP HEAVY DUTY LADDER
- 36399 3 STEP HEAVY DUTY LADDER
- 36401 4 STEP HEAVY DUTY LADDER
- 36403 5 STEP HEAVY DUTY LADDER

MISSOULA THERAPY LADDER

The Missoula Therapy Ladder™ offers low cost access.

- Supports 400lb load
- 10" average rise
- Non-slip 22" steps
- 1.5" diameter raised hand rail
- 15° slope allows for ease of entry and egress

- 25013 3 STEP MISSOULA THERAPY LADDER
- 25019 4 STEP MISSOULA THERAPY LADDER
- 25025 5 STEP MISSOULA THERAPY LADDER

BOZEMAN ADA THERAPY STEPS

These portable therapy steps are custom designed to provide proper fit and easy access.

- Supports 400lb load
- 23¹/₂" wide treads
- Slip-resistant and UV stabilized steps
- Durable 4" wheels for ease of transport
- Poly netting provided under stairs to avoid entrapment
- 1.5" diameter raised handrail

- 57920 3 STEP BOZEMAN ADA THERAPY STEPS
- 57921 4 STEP BOZEMAN ADA THERAPY STEPS
- 57922 5 STEP BOZEMAN ADA THERAPY STEPS
- 57923 6 STEP BOZEMAN ADA THERAPY STEPS

1.5" SPECTRALOCK™ COMPRESSION ANCHOR

- 42696 SPECTRALOCK™ COMPRESSION ANCHOR
- 24094 SPANNER WRENCH
- 24098 COMPRESSION ANCHOR CAP





DIVE STANDS



CHEYENNE DIVE STANDS

The Cheyenne meets all competitive diving regulations and is designed for use with in-ground swimming pools. Fabricated from 304L stainless steel with an exclusive passivation process to ensure maximum corrosion resistance. Ladders are included. Custom fabrication is available for any application.

- Conforms to NSPI standards for diving portions of Class B and C swimming pools
- Rear or side access available
- Accepts all manufactured diving boards in lengths of 10' to 16'
- 26" sloping treads with integral non-slip surface and UV inhibitors
- All main support columns are flanged for ease of installation
- Foot adjustable fulcrum and hinged diving board assembly included

22121	1M REAR ACCESS CHEYENNE DIVE STAND
22123	1M SIDE ACCESS CHEYENNE DIVE STAND
22140	REAR ACCESS ANCHOR KIT
22160	SIDE ACCESS ANCHOR KIT



1/2, 3/4, 1M SHORT STAND

47061	1/2, 3/4, 1M SHORT DIVE STAND – REAR ACCESS
47061	1/2, 3/4, 1M SHORT DIVE STAND – SIDE ACCESS
19177	SHALLOW ANCHOR FOR DIVE STAND



DURAFIRM SHORT STAND

Designed for use on concrete pedestals or platforms. DuraFirm short stands have fulcrum units identical to the 1M and 3M stands.

22060	DURAFIRM SHORT STAND – RAILS BOTH SIDES
22090	DURAFIRM SHORT STAND – NO RAILS
22100	DECK ANCHORS (SET OF 6)



DURAFIRM 1M STAND

This 1M duraFirm stand is supplied with top and intermediate handrails on both sides.

22030	DURAFIRM 1M STAND – RAILS BOTH SIDES
22020	DURAFIRM 1M ANCHOR SET (SET OF 8)



DURAFIRM 3M STAND

The 3M diving stand consists of heavy aluminum castings with roller and tracks that are anodized, heat-treated, extruded aluminum. The design of the ladder puts support directly under the mounting location of the diving board to further enhance stability. The ladder features built-in hand rails which provide a comfortable grip and wide steps with a replaceable slip-resistant slotted tread that matches the Duraflex diving board. Configurations available to mount on new or existing decks.

22010	DURAFIRM 3M DURAFIRM STAND – RAILS BOTH SIDES
22020	DURAFIRM 3M ANCHOR (SET OF 8)

DIVING BOARDS

PLEASE NOTE: POOLS MUST MEET MINIMUM STANDARDS FOR INSTALLATION.



RECREATIONAL ALUMINUM DIVING BOARDS

Proven "I" beam extrusions are epoxy glued with welded end construction. The nonslip surface resists wear. Each board comes with mounting hardware. Choose from marine blue, tile blue or radiant white finish.

- 22400 10' ALUMINUM BOARD
- 22410 12' ALUMINUM BOARD
- 22420 14' ALUMINUM BOARD
- 22430 16' ALUMINUM BOARD

COMMERCIAL FIBERGLASS DIVING BOARD

This heavy-duty, commercial diving board features a solid horizontally laminated wood core completely encased in fiberglass. Each board has a slip-resistant top tread and is tapered for superior performance. Stainless steel hardware kit included.

- 22300 10' FIBERGLASS BOARD
- 22310 12' FIBERGLASS BOARD
- 22320 14' FIBERGLASS BOARD
- 22330 16' FIBERGLASS BOARD



DURAFLEX DIVING BOARDS

High-quality springboard diving equipment that is the standard in the diving industry. Duraflex boards are made of single piece ribbed extruded aluminum alloy with a top surface coated in aqua-colored thermal-curing epoxy resin. The board is finished with a laminate of flint silica and alumina, between coats of epoxy to provide a slip-resistant surface.

- Heat treated for superior yield strength of 50,000 psi
- Slip-resistant surface

DURAFLEX ALUMINUM BOARD

This board is ideal for recreational diving in commercial pools.

- 22210 14' DURAFLEX
- 22220 16' DURAFLEX

MAXIFLEX "B" BOARDS

This board is seen in most major competitive diving events in the world. The Maxi-B is slightly lighter in weight and is said to give a quicker action in the hurdle step. The double-tapered design allows the whole board to arc while flexing, giving it approximately 15% more lift than the standard Duraflex.

- Used in most major diving competitions in the world
- Lighter weight
- Provides quicker action in hurdle step
- Double-taper design offers superior lift

- 22240 MAXIFLEX B - 16'

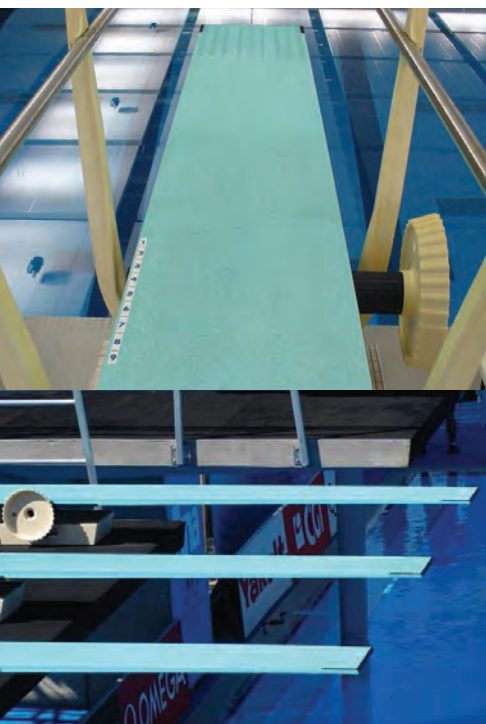

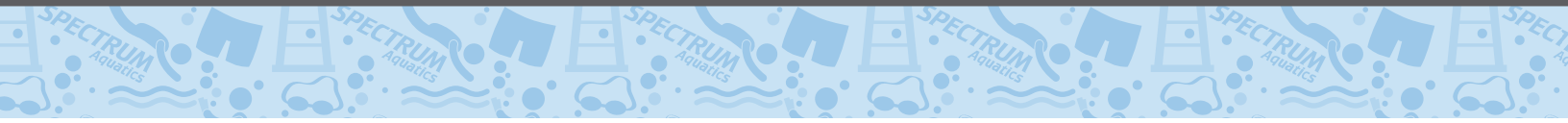

20110 4' MARSHALL

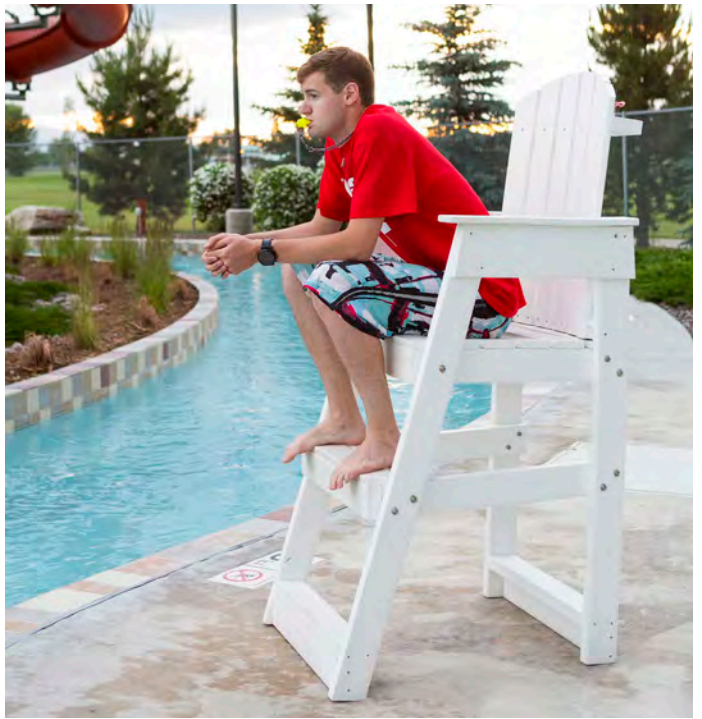

42022 36" MENDOTA



20160 6' DISCOVERY

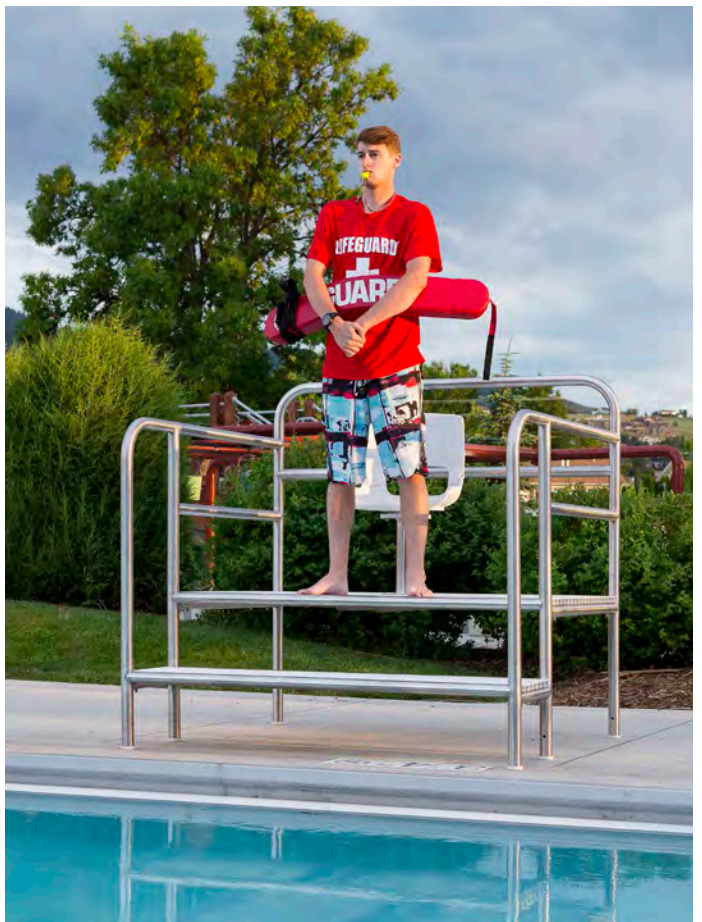

40923 42" OBSERVATION STATION

LIFEGUARD CHAIRS

Spectrum Aquatics® offers a complete selection of moveable and permanent lifeguard chairs. Chairs come in varying heights and widths to accommodate the safety requirements and needs of all indoor and outdoor commercial aquatic facilities.

Features:

- Non-slip footboards, platforms and ladder treads
- UV-protected guard seats
- Stainless steel components passivated and protected by SpectraShield® to provide a uniform and highly corrosion-resistant finish
- Rescue tube holder and umbrella mounting brackets included
- Moveable lifeguard chairs include wheels for ease of transport
- 1.9" OD with .065" tubing wall thickness for extra strength and stability
- 1.5" tubing type and 316 stainless steel available upon request

PERMANENT LIFEGUARD CHAIRS



HYALITE

This lifeguard chair was designed to conform to federal OSHA regulations, as mandated in some states. All guard rails are the compliant height and forward distance from the platform. Chair features a 360° swivel chair and a rear access ladder.

36521 6' HYALITE
20013 HYALITE ANCHOR



STIMSON

The rugged Stimson is a space-saving lifeguard chair that features an angled ladder assembly for safety and comfort. The 360° swivel chair aids in active viewing. 15 percent angle for safety and comfort.

57308 5' STIMSON LIFEGUARD PLATFORM
44116 6' STIMSON LIFEGUARD PLATFORM
20013 STIMSON ANCHOR



SAPPHIRE

The space-saving Sapphire enables a minimal setback and is ideal for rollout gutter pools. It features a 360° swivel chair.

36462 6' SAPPHIRE
20021 SAPPHIRE ANCHOR

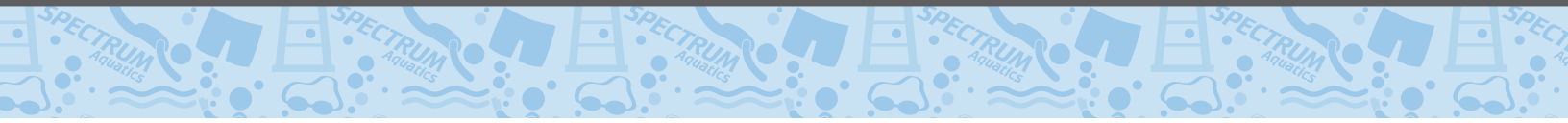

MOVEABLE LIFEGUARD CHAIRS



DISCOVERY

This lightweight, yet sturdy unit enables the lifeguard to oversee any area of the pool and features a 360° swivel chair. Optional Ballast System provides extra stability.

(BALLAST IS NOT INCLUDED)

- 20140 5' DISCOVERY
- 20160 6' DISCOVERY
- 20170 8' DISCOVERY
- 20145 PLATFORM BALLAST SYSTEM FOR DISCOVERY



TORREY II

The low profile Torrey II is readily movable and allows for a rapid exit while maintaining an excellent line of sight. It features a 360° swivel chair.

- 24742 36" TORREY II
- 24743 42" TORREY II
- 24744 48" TORREY II



MARSHALL

The Marshall can be used for lifeguarding, judging, coaching or instructing. This lightweight platform is easy to transport. Optional Ballast System provides extra stability.

- 20110 4' MARSHALL
- 20100 6' MARSHALL
- 20148 PLATFORM BALLAST SYSTEM FOR MARSHALL



HILGARD

The versatile Hilgard provides multiple entrances, enabling two guards to be on the platform at the same time. Steel railing in back adds safety and a split rail in front offers an unobstructed view. Platform features extra-wide side mount ladders and a 360° swivel chair. Made of 1.50" O.D. x .083" rail.

- 20121 5' HILGARD



OBSERVATION STATION

The Observation Station has a front entry and elevated viewing station. The wide front step brings the lifeguard closer to the pool edge. The chair is portable and has a 360° swivel to aid active viewing. Made of 1.50" O.D. x .083" rail.

40923 42" OBSERVATION STATION



MENDOTA

The Mendota is made of recycled high-density polyethylene material.

- Shipped with minimal assembly required – 80% factory assembled
- Resistant to corrosive substances, oil, insects, fungi, salt spray, rust and other environmental stresses
- 316 stainless steel hardware for maximum corrosion resistance
- Will not rot, splinter or crack
- Does not absorb moisture
- Wheels included on the 3' and 4' chair for portability
- Optional Ballast System provides extra stability
- Available in white only

42022 3' MENDOTA

45023 4' MENDOTA

47747 5' MENDOTA

54481 5' SIDE STEP MENDOTA

GUARD CHAIR ACCESSORIES



COMMON ACCESSORIES

29914 FOLDING REPLACEMENT SEAT

77119 QUICK CONNECT

24413 26" REPLACEMENT TREAD

24414 22" REPLACEMENT TREAD



PLATFORM BALLAST SYSTEM

Ballast System is designed to provide extra stability for platforms with easy attachment to existing portable platforms. Ideal for high-wind and heavy-use applications. Made of molded LDPE and equipped with top and side mounted fill and drain ports.

- Mounting hardware included
- Weighs approximately 185 lbs when filled with water

20148 BALLAST SYSTEM FOR MARSHALL

20145 BALLAST SYSTEM FOR DISCOVERY

20180 BALLAST SYSTEM FOR MENDOTA

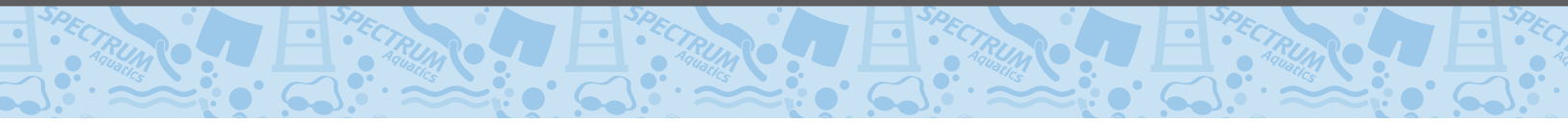

RECREATIONAL POOL SLIDES - SINGLE, DOUBLE & TRIPLE FLUMES

Bring fun and excitement for all ages with the new Single, Double or Triple Flume Pool Slides.

- Top platform and steps offer visibility to lifeguards and users with UV stabilized clear polycarbonate viewing windows
- Structure is fabricated of passivated 304L stainless steel to withstand harsh aquatic environments
- 316L stainless steel hand rails are designed for optimal gripping
- Flumes are fabricated of UV protected, rotationally molded low-density polyethylene (LDPE)
- Non-slip deck and step treads
- Deck size: 6'1 x 6'w x 4'8"h
- Slide height: 6' to center of tube
- Installs easily on new or existing decks
- Powder coating options available

FLUMES ARE AVAILABLE IN THE FOLLOWING COLORS:

STANDARD COLORS:

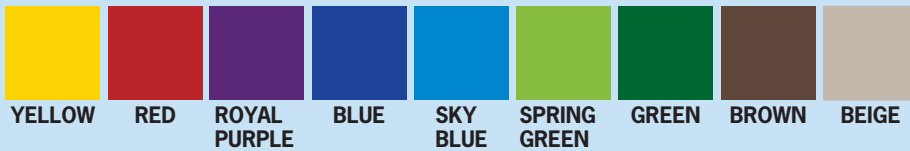

ECO COLORS: (higher recycled content)



ULTIMATE SLIDE 8'-8"

Flume Options: 1 or 2 flumes
 Flume Length: 20'
 Tower Height: 8'
 Minimum Water Depth: 4'*
 Flow Rate: 5gpm



- 135150 ULTIMATE SLIDE 8'- 8" - DOUBLE FLUME
- 140900 ULTIMATE SLIDE 8'- 8" - SINGLE FLUME - LEFT
- 140901 ULTIMATE SLIDE 8'- 8" - SINGLE FLUME - RIGHT

*FOR WATER DEPTH REQUIREMENTS PLEASE CONSULT WITH YOUR LOCAL STATE CODE



POOL SLIDE 4'-8"



Flume Options: 1 or 2 flumes
 Flume Length: 20'
 Tower Height: 8'
 Minimum Water Depth: 4'*
 Flow Rate: 5gpm

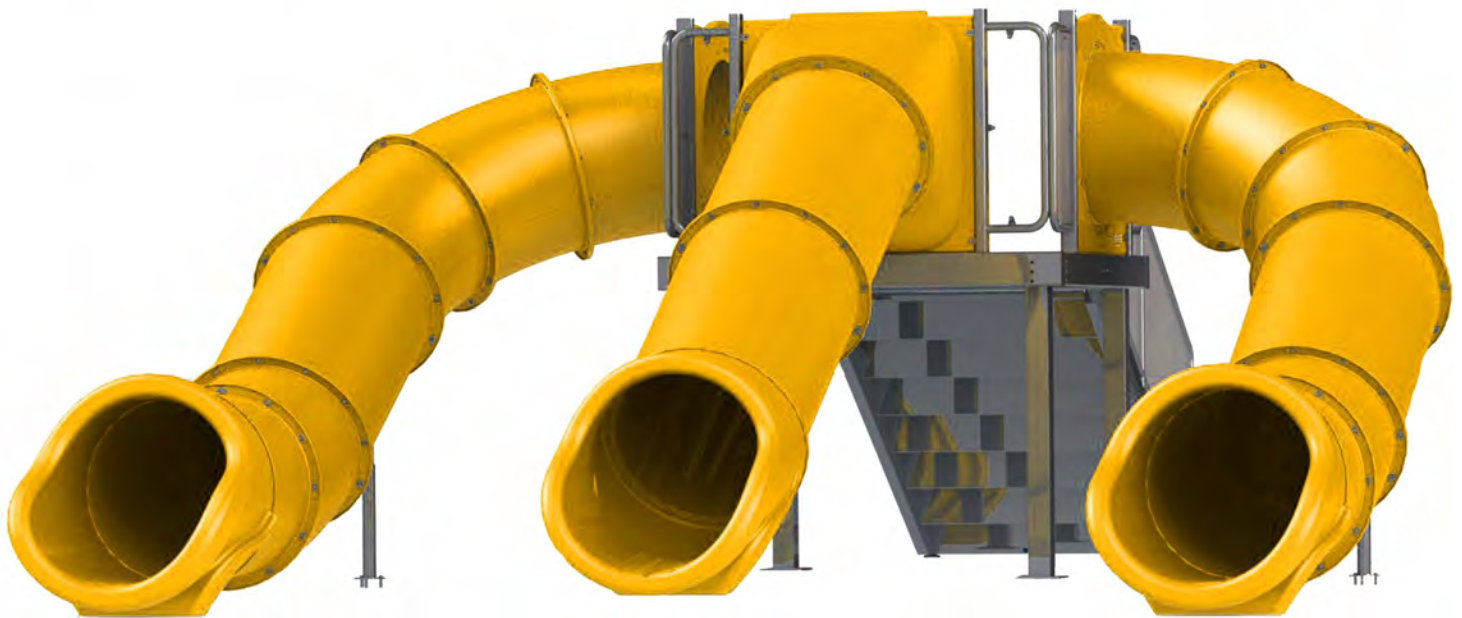
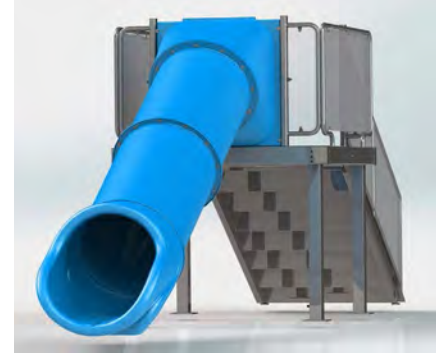

- 133100 POOL SLIDE 4' - 8"- SINGLE FLUME - RIGHT - REAR STAIR
- 133020 POOL SLIDE 4' - 8"- SINGLE FLUME - CENTER - REAR STAIR
- 133003 POOL SLIDE 4' - 8"- SINGLE FLUME - LEFT - REAR STAIR
- 133420 POOL SLIDE 4' - 8"- SINGLE FLUME - STRAIGHT - RIGHT HAND STAIRS
- 133403 POOL SLIDE 4' - 8"- SINGLE FLUME - ANGLE - RIGHT HAND STAIRS
- 133502 POOL SLIDE 4' - 8"- SINGLE FLUME - STRAIGHT - LEFT HAND STAIRS
- 133510 POOL SLIDE 4' - 8"- SINGLE FLUME - ANGLE - LEFT HAND STAIRS

- 133423 POOL SLIDE 4' - 8"- DOUBLE FLUME - RIGHT HAND STAIRS
- 133512 POOL SLIDE 4' - 8"- DOUBLE FLUME - LEFT HAND STAIRS
- 133120 POOL SLIDE 4' - 8"- DOUBLE FLUME - SLIDES ON RIGHT & CENTER - REAR STAIR
- 133023 POOL SLIDE 4' - 8"- DOUBLE FLUME - SLIDES ON LEFT & CENTER - REAR STAIR
- 133103 POOL SLIDE 4' - 8"- DOUBLE FLUME - SLIDES ON RIGHT & LEFT REAR STAIR
- 133123 POOL SLIDE 4' - 8"- TRIPLE FLUME - REAR STAIR

*FOR WATER DEPTH REQUIREMENTS PLEASE CONSULT WITH YOUR LOCAL STATE CODE



WATER SPORTS

DAWSON WATER POLO GOAL



Adjustable water polo goal meets FINA, NCAA, NFSHSA and US Water Polo regulations for both deep & shallow settings.

- Easy to install, remove and store with hinged mounting legs which fold flat for storage
- Protective rubber bumpers included
- 304L stainless steel – 316 available upon request
- Accommodates 7", 30" or 36" setback – custom setbacks available
- Cage supplied with UHMW facia and reinforced black HTPP backdrop

- 84299 DAWSON WATER POLO GOAL CAGE AND NET
- 84298 REAR LEG SET FOR 7" SETBACK
- 84297 REAR LEG SET FOR 30" SETBACK
- 84294 REAR LEG SET FOR 36" SETBACK
- 23638 6" BRONZE ANCHOR (2 REQUIRED PER GOAL)

ODYSSEY POLO GOAL



The Odyssey floating goal has been used in pools around the world since its introduction at the 2000 Sydney Olympics.

- Made of durable white powder-coated aluminum or stainless steel
- Three heavy-duty, hand-laid fiberglass flotation panels are located on each side and in back to provide necessary buoyancy
- Net is made of tough polypropylene cord, knotted at every intersection
- Easy assembly by two people in one hour
- Conforms to all national and international specifications
- Dimensions: 152" W x 56" D x 42" H

- 84230 ODYSSEY POLO GOAL

OTHER FLOATING POLO GOALS



Polo goals are ideal for competitive water polo at the regional or local level.

- Made of durable white powder-coated aluminum or stainless steel
- Two flotation panels are constructed of durable, hand-laid fiberglass
- Net is made of tough polypropylene cord, knotted at every intersection
- Easy assembly by two people in one hour
- Conforms to all national and international specifications
- Dimensions: 152" W x 56" D x 42" H

- 84241 CLUB POLO GOAL
- 42613 UNIVERSAL GOAL
- 42614 SPLASHBALL GOAL
- 57436 FLIP FLOAT GOAL

WATER PLAY

BASKETBALL HOOP



The basketball kits are shipped with minimal assembly. Includes a net & backboards.

- Made from 304L stainless steel
- Clear backboard is acrylic with powder-coated supports
- Customization available

133058 SINGLE POST BASKETBALL HOOP

- Square Tubing
- Mounting hardware included

143094 J BOLT ANCHOR FOR SINGLE POST HOOP

57827 DUAL POST BASKETBALL HOOP

24060 STAINLESS STEEL ANCHORS (2 REQUIRED)

WATER EXERCISE

THERAPY BODY TRAINER



For conditioning and rehabilitation, the Body Trainer builds flexibility, strength and endurance.

- Provides a greater range of motion for arms, spine, hips and legs than that of land-based training
- Adjustable to accommodate differing heights
- Compatible to varying fitness levels
- 300 lb weight capacity
- Uses 1.5" anchors (sold separately)

54466 THERAPY BODY TRAINER

42696 COMPOSITE COMPRESSION ANCHOR (2 REQUIRED)

24094 WRENCH FOR COMPOSITE COMPRESSION ANCHOR

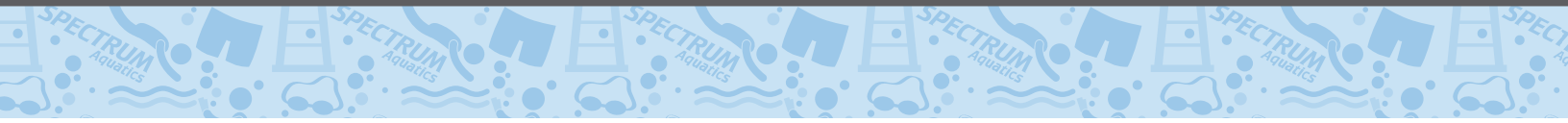

SWIMMING POOL COVERS REDUCE ENERGY CONSUMPTION & MORE

Pool Blanket Systems can offer significant energy savings and drastically reduce water and chemical consumption as well as cleaning time by keeping dirt and other debris out of the pool or spa. They often pay for themselves in less than one year when properly and consistently used.

- Conserve water by reducing the amount of make-up water needed by 30%-50%
- Reduce chemical consumption by 35%-60%
- Reduce maintenance and pool cleaning costs by keeping dirt and debris out of the pool
- Reduce corrosion of indoor facilities, extending the life of equipment

“Covering a pool when it is not in use is the single most effective means of reducing pool heating costs. Savings of 50% - 70% are possible.”

-U.S. Department of Energy

HOW THEY WORK

Swimming pools lose energy in a variety of ways, but evaporation is by far the largest source of energy loss. Replacing evaporated water requires tremendous amounts of energy. It only takes 1 BTU (British thermal unit) to raise 1 pound of water 1 degree, but each pound of 80° F water that evaporates takes a whopping 1,048 BTU of heat out of the pool.

The evaporation rate from an outdoor pool varies depending on the pool's temperature, air temperature and humidity and the wind speed at the pool surface. Indoor pools aren't subjected to the environment, but they still lose a lot of energy from evaporation and require room ventilation to control indoor humidity caused by the large amount of evaporation. The ventilated air also must be conditioned, which adds to the energy costs.

Pool covers minimize evaporation in both outdoor and indoor pools. Covers on indoor pools not only reduce evaporation but also the need to ventilate indoor air and replace it with unconditioned outdoor air. You can also shut off exhaust fans when an indoor pool is covered, saving even more energy.

Information obtained from the U.S. Department of Energy www.energysavers.gov

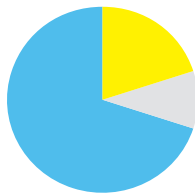

OUTDOOR POOL ENERGY LOSS CHARACTERISTICS:

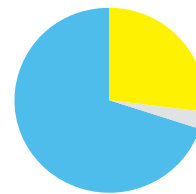
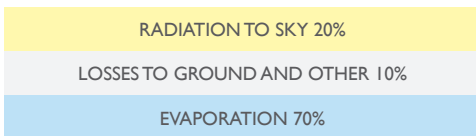

INDOOR POOL ENERGY LOSS CHARACTERISTICS:

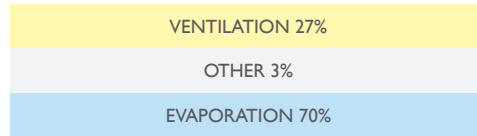



THERMAL-KING® POOL COVERS



These superior, energy-saving blankets will outlast all others and offer significant energy savings. Covers are made of a five-layer system to insulate and protect. The heavy duty material is UV protected and engineered to provide the most efficient energy saving system for your pool.

ENERGY SAVING POOL COVERS

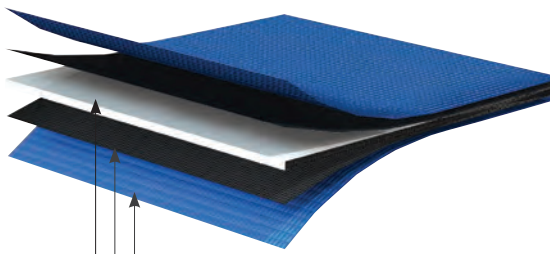

3.0 Mils LDPE, UV protected coating,
UV high density polyethylene

EVA enhanced insulating polyethylene
foam, Volara 1/8"



- Easy to deploy and retrieve
- Blankets are reversible
- Available in standard and custom sizes
- Advanced performance – 100% stabilized polyester woven 20 x 20 denier
- Longer life – coated and UV stabilized on both sides for maximum protection
- Superior strength edging – made with PVC coated tarpaulin – will not chalk or flake
- Extruded black vinyl incorporated into edging for weight
- Strategically located water vent holes with weighted edge help covers hold in windy environments
- Panels come complete with heavy-duty, UV inhibited loop ties for attaching the panels to a storage reel system
- Loop ties made of 5/16" heavy-duty synthetic fiber rope
- 304 stainless steel grommets for maximum corrosion resistance
- Material Types 10 x 14, 10 x 10 & 12 x 12

- 47129 POOL BLANKET
- 208200 LOOP TIES
- 50021 18" LEAD STRAP (fastens blanket to winder)

ENERGY SAVING SPA COVERS

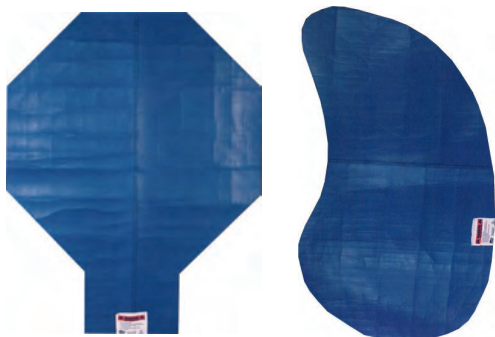

Spa covers offer the same benefits as the pool covers except for the edging, as spa covers come unedged. Using household scissors you can cut them to fit your spa's custom configuration.

- 500019 SPA SHEET 10' x 10'
- 500020 SPA SHEET 15' x 15'
- 47129S CUSTOM EDGED SPA BLANKET



BLANKET STORAGE SYSTEMS – BITTERROOT DECK SERIES



The Bitterroot blanket storage systems ensure proper handling and storage of pool blankets. Made of electropolished 304L stainless steel, they are portable, strong and designed to support the weight of wet blankets.

- Easy to deploy and retrieve pool blankets
- Employs nickel-plated pillow block reel tube bearings
- Equipped with stainless steel crank assembly
- Utilizes 6" diameter, non-marring polyethylene wheels
- Equipped with two foot-operated brakes
- Accommodates a maximum blanket width of 20'
- Optional cover is available

BITTERROOT STORAGE SYSTEMS



50120 BITTERROOT I - SINGLE TUBE WINDER

- Storage capacity of 164 linear feet or 3,280 sq. ft.
- Total weight capacity of 643 lbs.

50150 BITTERROOT II - DOUBLE TUBE WINDER

- Storage capacity of 328 linear feet or 6,560 sq. ft.
- Total weight capacity of 1,102 lbs.

50180 BITTERROOT III - TRIPLE TUBE WINDER

- Storage capacity of 492 linear feet or 9,840 sq. ft.
- Total weight capacity of 1,562 lbs.

WINDER COVERS



14922 SINGLE WINDER COVER

14938 DOUBLE/TRIPLE WINDER COVER



STORAGE SYSTEMS – BLACKFOOT WALL MOUNT



Manually-operated or semi-automatic, wall-mounted pool blanket storage systems that conserve deck space and allow for ease of blanket retrieval and deployment. Structurally designed to support the weight of wet blankets, the Blackfoot is manufactured of 304L stainless steel, which is electropolished and passivated to withstand harsh aquatic environments. Accommodates up to 164 linear feet.

BLACKFOOT WALL MOUNTED STORAGE SYSTEMS

50220 BLACKFOOT I

The Blackfoot I is built for blanket widths up to 20 feet. The storage system can typically accommodate two panels and up to 164 linear feet.

50009 REPLACEMENT CRANK HANDLE

50200 BLACKFOOT II

The Blackfoot II is a radio controlled semi-automatic wall mounted blanket storage system. A simple hand-held transmitter provides smooth deployment and retrieval of pool blankets. The solid state electronics are contained in a water tight, NEMA 4 enclosure, ensuring dependable operation and long life. Automatic, no crank needed. Operating current of 115 VAC, 1 phase, 60 cycles. Designed to support blankets of up to 20' wide with a maximum storage capacity of 164 linear feet.

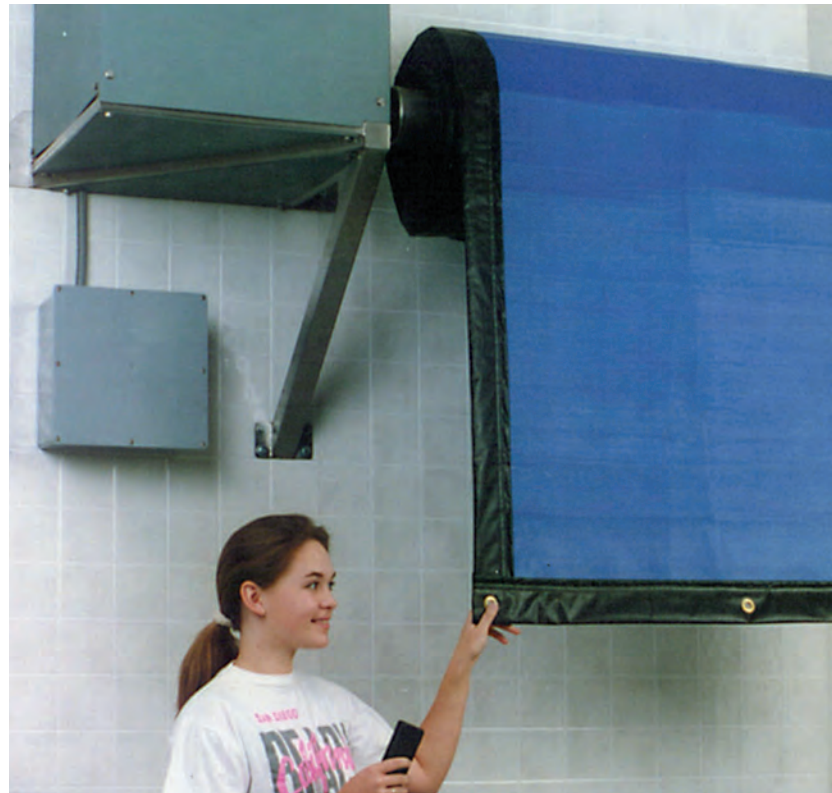
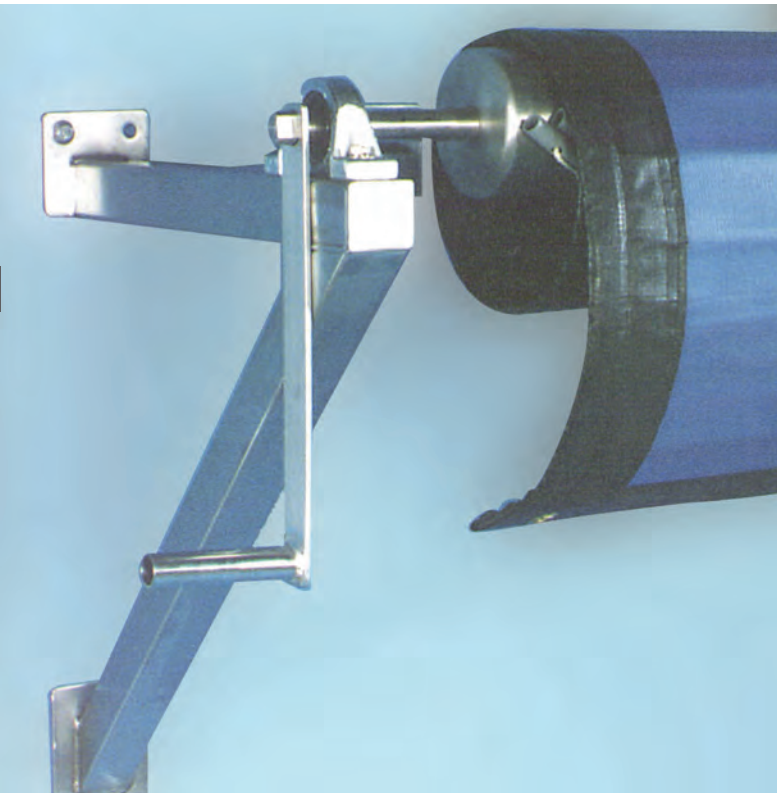

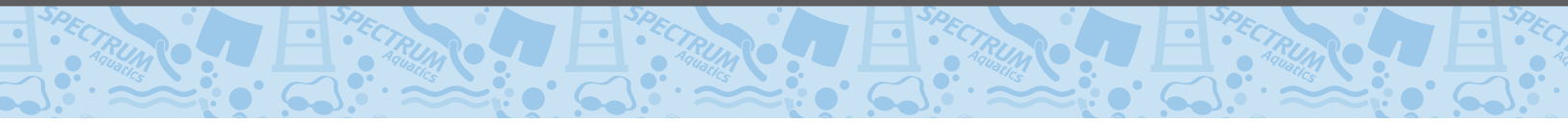

ANCHORS AND PARTS

SINGLE POST ANCHOR FOR STARTING BLOCKS

This unique patented anti-wobble locator pinned design is superior to other single-set type anchors.

- No tools required when installing or removing starting platform
- Machined bronze – ensures extremely tight tolerances, won't warp or flex like thin walled imbeds and offers superior corrosion resistance
- Locating slot design – eliminates rotation and guarantees proper alignment of platform
- Includes stainless steel lid and removal tool

- 21700 SINGLE POST ANCHOR
21705 SINGLE POST ALIGNMENT TOOL



DUAL POST ANCHOR ASSEMBLY FOR STARTING BLOCKS

Designed for use with dual post starting blocks like the Cougar and Bighorn. Fabricated of 304L stainless steel. Welded fixture design allows for easy installation. Anchors are set exactly center to center for ease of platform installation and removal. Anchors provided with bonding lug, caps and removal key.

- 24070 6" DEEP DUAL POST ANCHOR SET
24071 10" DEEP DUAL POST ANCHOR SET



CUP ANCHOR

For securing racing lines and safety ropes in concrete and gunite pools. The 4" cup is stainless steel construction. Kit includes a bonding screw.

- 58316 4" STAINLESS STEEL CUP ANCHOR WITH REMOVABLE EYEBOLT
58280 3" ROUND WITH REMOVABLE EYEBOLT, CHROME PLATED BRONZE



BRONZE STANCHION 6" ANCHOR KIT

For 1.90" O.D. stanchions, water polo goals or Traveler lift. Kit includes anchor, lid and key.

- 23638 BRONZE 6" ANCHOR KIT
36450 LID AND KEY REPLACEMENT FOR BRONZE 6" ANCHOR



STAINLESS STEEL STANCHION ANCHOR

6" for 1.90" O.D. for stanchions, water polo goals or basketball hoops. Includes anchor, lid and key. Made entirely of 316 grade stainless steel.

- 24060 STAINLESS STEEL STANCHION ANCHOR



4" STANDARD-DUTY BRONZE ANCHOR

For rails, ladders and other deck equipment.

- 24010 4" STANDARD-DUTY BRONZE ANCHOR FOR 1.90" RAILS
54052 4" STANDARD-DUTY BRONZE ANCHOR FOR 1.50" RAILS





STAINLESS STEEL COVER FOR BRONZE WEDGE ANCHOR



24012 304L STAINLESS STEEL COVER FOR 1.90" BRONZE WEDGE ANCHOR

STAINLESS STEEL WEDGE ANCHOR



Stainless steel wedge anchor for 1.50" O.D. railings. Body is 6" deep and is 304L cast stainless steel; wedge is cast bronze and hardware is 304L stainless steel.

24090 STAINLESS STEEL WEDGE ANCHOR FOR 1.50" RAILS

1.5" SPECTRALOCK™ COMPRESSION ANCHOR



Engineered to address corrosion issues in pool environments and provide easier rail and ladder installation.

- Reduces maintenance costs & cleaning time
 - Eliminates debris, corrosion and heavy water deposits typically found lodged between the wedge anchor inside wall and assembly
 - Ideal for underwater installation of handrails and ramp rails where rust bleeds can reduce water quality
 - Ideal for removing and installing ladders or rails during pool deck maintenance, repairs and renovation
 - Eliminates alignment issues and the need for frequent bolt tightening common with wedge anchor assembly
- Sturdy and aesthetic
 - Built-in anchor compression ring applies even pressure on tubing, decreasing potential damage to rail or ladder
 - Escutcheonless, flush-mount design gives the rail and deck a finished look
 - Accommodates recommended ADA handrail and ladder tubing diameters
- Protected by U.S. Patent 7437857



42696 SPECTRALOCK™ COMPRESSION ANCHOR
 24094 SPANNER WRENCH
 24098 COMPRESSION ANCHOR CAP
 23636 ANCHOR KEY

ESCUTCHEON PLATES



35214 316 STAINLESS STEEL KEYHOLE WITH 316 SET SCREW FOR 1.90" O.D. RAILS
 35222 316 STAINLESS STEEL KEYHOLE WITH 316 SET SCREW FOR 1.50" O.D. RAILS
 24120 STAINLESS STEEL ROUND ESCUTCHEON FOR 1.90" O.D. RAILS
 24095 1.50" ROUND ESCUTCHEON 316L STAINLESS STEEL
 57341 ABS CHROME 1.90" ESCUTCHEON
 57423 ABS CHROME 1.50" ESCUTCHEON



LADDER BUMPERS



- 30038 FEMALE 1.50" O.D.
- 30021 FEMALE 1.90" O.D.
- 16644 MALE 1.90" O.D.

UNIVERSAL REPLACEMENT TREAD FOR LADDERS



- Made of UV stabilized polypropylene
- 20" L x 4" W
- Converter attachment allows for use with both 1.50" and 1.90"

44986 UNIVERSAL REPLACEMENT TREAD

SPECTRUM REPLACEMENT TREAD FOR LADDERS



- Made of high-density polyethylene (HDPE)
- 20" long, with a curved design featuring a 6" width at the center and 3¼" at the ends
- Available for 1.50" and 1.90" O.D. rails
- Hardware included

24411 REPLACEMENT TREAD FOR 1.50" O.D. RAIL

24412 REPLACEMENT TREAD FOR 1.90" O.D. RAIL

REPLACEMENT TREADS FOR GUARD CHAIRS



Treads are 5 1/16" at the center, 4" at the ends, with dimensions measured center-to-center between rails.

- Hardware included

24413 26" ABS SLOPING 15 DEGREES 1.90"

24414 22" ABS SLOPING 15 DEGREES 1.90"

BACKSTROKE START DEVICE AND ACCESORIES



143081 BACKSTROKE START DEVICE WITH STRAP

143061 POP - UP ANCHOR

143062 CUSTOM ATTACHMENT



PORTABLE FILTRATION SYSTEMS

Spectrum Aquatics® manufactures a wide variety of portable filtration systems to support all pool sizes. Made from stainless steel and incorporating durable Sta-Rite® pumps, these vacuums provide durability and dependability. All metallic components are passivated for maximum corrosion resistance. In addition, every stainless steel product manufactured by Spectrum is protected by Spectra-Shield. Hoses, fitting kits and vacuum heads sold separately.

- Stainless steel filter canister and cart
- Heavy-duty pneumatic wheels
- 1.5" or 2" shut off valves and quick-connect hose fittings
- Outfitted with a 155 or 105 square foot Harmsco® filter

WILDCAT PORTABLE FILTRATION SYSTEMS

The Wildcat E1 pump cart uses a 1 HP, 110 VAC Sta-Rite Dyna-Pro pump to move approximately 5,400 gallons of water per hour.

- 100' electrical cord
- GFCI shock protector

I0670 WILDCAT E1

The Wildcat E1.5 is ideal for the small hotel/motel pools. This pump cart uses a 1.5 HP, 220 VAC, Sta-Rite Dyna-Pro pump to move approximately 7,300 gallons of water per hour.

- 100' electrical cord
- GFCI shock protector

I0610 WILDCAT E1.5

The Wildcat E2 is for large facilities with 220 volt outlets. This pump cart uses a 2HP, Sta-Rite Dyna-Pro pump to move approximately 8,000 gallons of water per hour.

- 100' electrical cord
- GFCI shock protector

I0620 WILDCAT E2

The Wildcat G3.5 gas engine model is for large outdoor facilities where electrical access may be limited. This unit moves approximately 8,000 gallons of water per hour.

I0640 WILDCAT G3.5

The Wildcat G5.5 pump cart uses a 5.5 HP gas engine driven pump. The unit moves approximately 9,300 gallons of water per hour.

I0660 WILDCAT G5.5



HARMSCO PORTABLE PUMP CART

Economical units for cleaning mid-sized pools. These units include a Sta-Rite pump. Hoses, fitting kit and vacuum head are sold separately.

- Stainless steel filter canister and cart
- 100' electrical cord
- GFCI shock protector
- 1 HP unit comes with value driven 105 sq.ft. filter

I0700 BKP 1 HP 110 VAC (1.5" connection)

I0720 BKP 2 HP 220 VAC (2" connection)





SAVAGE PUMP

Each vacuum pump includes Sta-Rite pump, stainless steel cart, a check valve on the pump suction, gate valve on the pump discharge, a hose bib connection for easy priming, 100' of power cord with a waterproof switch and barbed hose fittings for the connection of discharge and suction hoses.



- Stainless steel cart
- 6" hard rubber wheels
- 100' electrical cord
- GFCI shock protector

- 11100 SAVAGE 1 HP, 110VAC
1½" suction and 1½" discharge with flow rates to 5000 gallons of water per hour.
- 11110 SAVAGE 1½ HP, 220VAC
2" suction and 2" discharge with flow rates to 6500 gallons of water per hour.
- 11120 SAVAGE 2 HP, 220VAC
2" suction and 2" discharge with flow rates to 8000 gallons of water per hour.

PUMP CART

This high quality stainless pump cart is a compact unit, prepunched to accept most American-made pumps. It includes a cord holder and 6" hard rubber wheels.



- 10780 PUMP CART

HEAVY DUTY HOSE CADDY

Durable stainless steel reel which stores vacuum hose when not in use. The portable caddy holds up to 75' of 2" hose or 175' of 1½" hose.



- 12500 HOSE CADDY

SPECTRA-CLEAN™ STAINLESS STEEL CLEANER

Stainless steel is a corrosion resistant alloy; however it may display rusting characteristics under certain conditions. Routinely wiping down rail surfaces and rinsing with unchlorinated water minimizes the potential for corrosion. In the event stainless equipment displays stubborn rust stains or heavy deposit build-up, our specialized cleaning materials will remove these foreign substances and restore the original rail finish.



- 47906 SPECTRA-CLEAN SYSTEM 1 — 4 PACK, 22OZ. EACH
Daily Use Stainless Steel Cleaning
- 47905 SPECTRA-CLEAN SYSTEM 2 — 1 GALLON
Extreme Use Stainless Steel Cleaning
- 47904 SPECTRA-CLEAN SYSTEM 3 — 1 GALLON
Severe Use Stainless Steel Cleaning





SPECTRUM AQUATICS® STANDARD TERMS & CONDITIONS OF SALE

TERMS

Terms of Sale are Net 30 Days based upon approval of credit. All products are shipped F.O.B. point of origin with shipping charges added to invoice. PAST DUE INVOICES WILL INCUR FINANCE CHARGES OF 1-1/2% PER MONTH (18% PER YEAR). Delinquent accounts will be liable for the invoice amount, finance charges, attorney fees and costs incurred to collect the past due amount. Purchase orders originating outside of the United States and Canada require prepayment or an irrevocable letter of credit at time of order entry. Call our customer service department for details.

CREDIT

To establish an account and a line of credit, a customer must be within the United States or Canada and you must complete a credit application and mail or email it to our credit department. Credit applications will not be accepted without a signature from an appropriate purchasing agent. Customers must include their desired amount of credit. Spectrum will not process applications with this field blank. Customers within the United States or Canada without a credit history may purchase products and pay cash with order, check by mail or charge the purchase of products to a credit/debit card (Visa, MasterCard or American Express). Spectrum pricing reflects a 5% discount for orders paid in accordance with established terms, with cash or check. The discount of 5% will not be applicable to orders paid by credit or non-standard terms.

CUSTOMER ORDERS

Minimum order amount is \$75.00; stocking distributors are exempt from this policy. Order placement requires a hard copy purchase order or signed copy of a quotation. If purchase order is verbal, with no hard copy (purchase order or signed quotation) confirmation, seller will not assume responsibility for errors related to, but not limited to, date of shipment, destination of shipment, items shipped or quantity of items shipped. Order must be shippable within 180-days of placement to hold original pricing. Purchase orders originating outside the United States and Canada require prepayment or an irrevocable letter of credit at time of order entry. Call our customer service department for details.

ORDER CANCELLATION

Orders for standard cataloged products, if canceled within 24 hours of order placement, will be assessed a \$200.00 cancellation fee. The seller must receive order cancellation in writing. Spectrum Aquatics will not accept cancellations after a period of 24 hours from order placement.

QUOTATIONS

Price quotations for standard products are valid for 30 days. Price quotations for commercial projects are valid for 90 days. Price quotations for custom design or special items are subject to change predicated on the information provided to seller at the time of quotation, as opposed to the definitive information presented at the time of order entry, engineering and fabrication.

WARRANTY

Products manufactured by Spectrum carry a two-year limited warranty. A three-year limited warranty is offered for stainless steel deck equipment and aquatic lift frames. Products sold through, but not manufactured by Spectrum, are warranted by the companies that have manufactured such products, and that manufacturer's warranty solely applies. Some exceptions apply, please see warranty. Thermal blankets may include a limited warranty up to 6 years for an additional charge. Please visit our website for more information.

FREIGHT CLAIMS

INSPECT YOUR FREIGHT IMMEDIATELY UPON DELIVERY. You are responsible for verifying the quantity and condition of the shipment upon receiving. If there is a concern related to the quantity of packages received, note this on the freight bill. If you notice any damage to the packaging, describe it on the freight bill and file a freight claim. If you suspect hidden freight damage, explain it on the freight bill, inspect immediately and contact the freight carrier within three days of delivery. **YOU ARE RESPONSIBLE FOR REPORTING HIDDEN DAMAGES WITHIN 3 DAYS FROM RECEIPT OF DELIVERY.** Seller will make every effort to assist with a freight claim; however, buyer must file the freight claim. It is important that upon receipt, the buyer or freight recipient inspect and count freight.

RETURNS/RESTOCKING FEE

Products may not be returned to seller without prior approval. Obtain a Return Materials Authorization (RMA) number from our Customer Service Department prior to returning materials. **RMA NUMBER MUST BE WRITTEN ON THE OUTSIDE OF EACH PACKAGE OF MATERIALS BEING RETURNED. SELLER WILL REJECT MATERIALS RETURNED WITHOUT BENEFIT OF AN RMA NUMBER.** Returns must be sent freight prepaid. Returns will be subject to a restocking charge of 20% of the purchase price. Items must be returned within 60 days of issuance of a RMA; if not returned within 60 days the RMA will be canceled. All freight costs associated with returns from the desired shipping point to Spectrum are the customer's responsibility. Materials that qualify for return must be returned within 120 days of invoice date. All materials returned must be in a new and unused condition to warrant any credit consideration. **DO NOT RETURN SALEABLE GOODS WITHOUT A RETURN MATERIAL AUTHORIZATION.** Your freight will be refused, and you will be responsible for freight charges both ways.

NOTE

- PRICES ARE SUBJECT TO CHANGE WITHOUT NOTICE.
- PRODUCT DESCRIPTIONS MAY VARY.
- PRODUCTS MAY BE SUBSTITUTED WHEN NECESSARY, WITH CUSTOMER APPROVAL.
- ANY CHECKS OR ELECTRONIC DEBIT AUTHORIZATION THAT ARE RETURNED FOR ANY REASON WILL BE CHARGED A \$30 NON-SUFFICIENT FEE.

SPECTRUM AQUATICS®

TWO YEAR LIMITED WARRANTY= AQUATIC LIFTS

THREE YEAR LIMITED WARRANTY= STAINLESS STEEL DECK EQUIPMENT & AQUATIC LIFT FRAME*

What is covered by this warranty? Spectrum Aquatics® warrants all products it manufactures to be free from defects in materials and factory workmanship to the original buyer. This warranty is contingent upon the proper use and care of the equipment, and does not cover equipment that has been modified or has been subjected to abusive physical or environmental stresses. Spectrum Aquatics® agrees to repair or replace, at its sole discretion, any product that fails to perform as specified within 24 months after date of the original shipment from the factory unless otherwise noted.

This warranty relates only to defects in materials and workmanship and does not include damage or failure resulting from other causes, including, but not limited to acts of God, misuse or abuse, accident or negligence, fire, improper installation, excessive heat or ice damage. This warranty does not apply to fading of materials or to any corrosion of any metallic parts. Damage induced by the improper use of chemicals is not covered by this warranty. In the event that products are altered or repaired by anyone without the prior written approval of Spectrum Aquatics®, all warranties are voided.

What will Spectrum do related to the product covered by this warranty? Provide free of charge (excluding shipping) replacement parts (new or rebuilt at Spectrum's option), but not labor to remove and install parts. Provide, F.O.B. the factory, new or reconditioned replacement product (Spectrum's option).

What is not covered by this warranty? Normal wear and tear, chemical damage, discoloration, misuse and any physical damage are not included in this warranty. See owner's manual for recommendations related to the use and care of the product. Improper storage of the Pool Blanket System may void this warranty.

How to make a warranty claim: Contact Spectrum Aquatics®, at 800.791.8056, or at 7100 Spectrum Lane, Missoula, MT 59808. Please include your phone number, contact name and address.

Your Rights Under State Law: This warranty gives you specific legal rights, and you may also have other rights, which vary from state to state. Spectrum Aquatics® disclaims all liability for damage during transportation, for incidental, special or consequential damage of whatever nature, for damage due to handling, installation, or improper operation, or for damage caused by circumstances beyond Spectrum Aquatics® control; in no event shall recovery of any kind against Spectrum Aquatics® be greater in amount than the purchase price of the equipment sold by Spectrum Aquatics® that caused alleged damage. Spectrum Aquatics® makes no warranties either expressed or implied, including any warranty of merchantability or fitness for particular purpose. Some states do not allow the exclusion or limitation of incidental or consequential damages, or limitations on how long an implied warranty lasts, so the above exclusions may not apply to you. No representative has authority to change or modify this warranty in any respect.

***Unless otherwise indicated**

ABOUT SPECTRUM AQUATICS®

For more than 40 years, Spectrum Aquatics® has been beating aquatic industry standards. We manufacture a broad array of quality aquatic products used in the construction and operation of commercial swimming pools and spas. We believe in building long-term relationships and wish to exceed the expectations of those who specify and use our products. We manufacture the finest products in the industry – possessing outstanding quality and workmanship – and our technical information support system is unequalled.

Spectrum is highly regarded within the pool and spa industry and is acknowledged for:

- Quality products with competitive pricing
- On time delivery
- Leadership in innovative products
- Friendly and caring customer service
- Superior engineering and field sales support

ABOUT PLAYCORE®

At PlayCore®, we are inspired by the creativity and motivation of the communities we meet - and relish the excitement that helping them realize their dream recreation space always generates. PlayCore® helps build stronger communities around the world by advancing play through research, education, and partnerships. Our company infuses this learning into our complete family of brands. We combine best in class planning and education programs with the most comprehensive array of recreation products available ranging from residential swing sets, commercial playground equipment, site amenities, commercial pool equipment, surfacing solutions, fitness and more. PlayCore® is the most trusted brand in play and recreation because we take a unique education-focused approach. We work closely with the communities we serve, to discover their vision and goals, then design recreation spaces to fulfill their needs, creating opportunities for personal and social growth.

LEARN MORE ABOUT OUR OTHER PLAYCORE AQUATIC BRANDS



spectrumproducts.com



coloradotime.com



fountainpeople.com

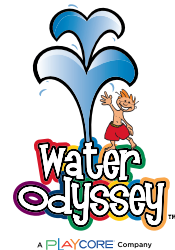

waterodyssey.com

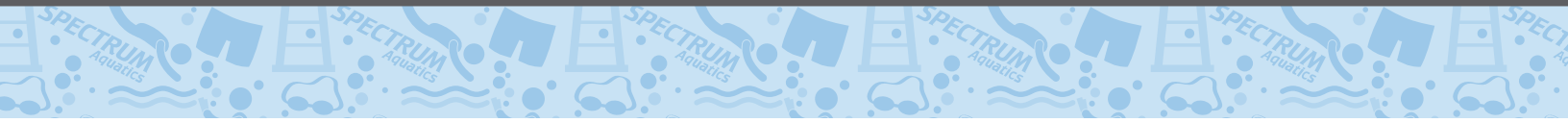

GUTTER MEASURING GUIDE

RECESSED GUTTER

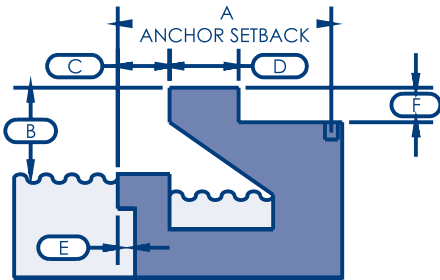

BULL NOSE COPING

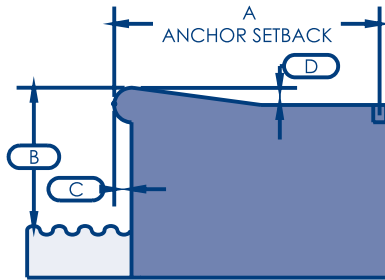

TROUGH GUTTER

Carpenters level required

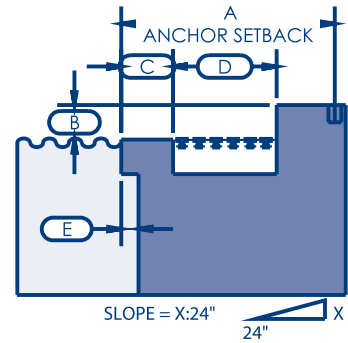

RIM FLOW GUTTER

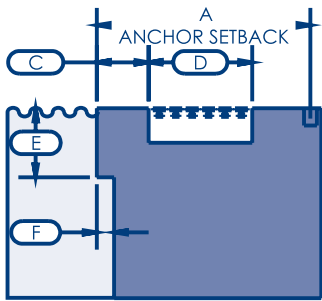

HAUNCH GUTTER

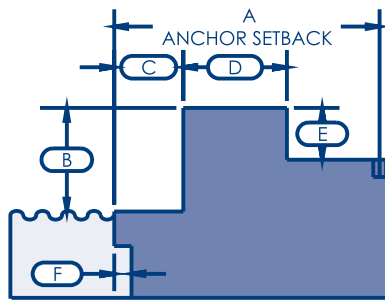

If you have current anchors for your water powered lift, please verify the anchor to anchor dimension

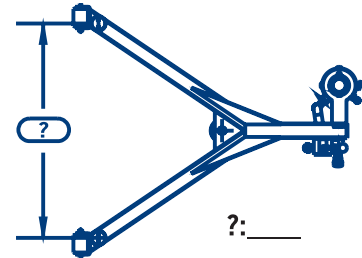

- A: _____
- B: _____
- C: _____
- D: _____
- E: _____
- F: _____



MEASURE GUIDE HANDRAIL

FORM MG-SRD

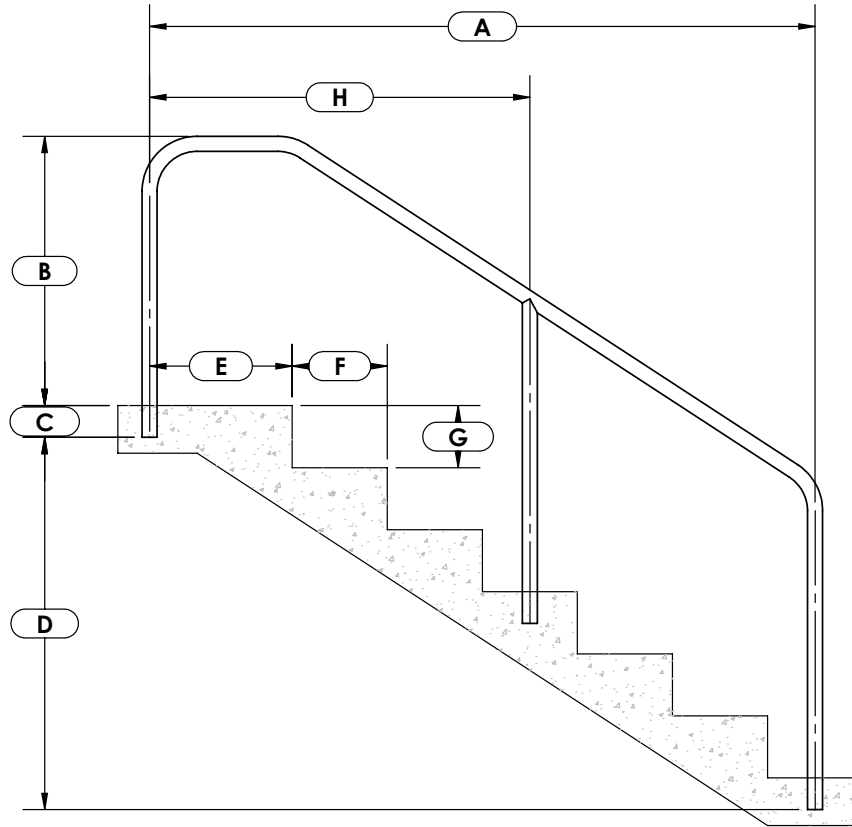

	DESCRIPTION	MEASUREMENT
A	RAIL WIDTH	
B	RAIL HEIGHT	
C	ANCHOR DEPTH	
D	OVERALL DROP	
E	RAIL SETBACK	
F	STEP RUN	
G	STEP RISE	
H	POST LOCATION *(OPTIONAL)	

NOTE:

Field measurements are required for the product you wish to order. Please provide accurate measurements to eliminate delays or errors in the design and manufacturing.

*Post Required: Post Spacing on 304 and 316 series stainless steel rails. (ADA Guidelines)

**Also available in 316 series stainless steel

It is the responsibility of the customer to ensure the handrail meets all local and state codes.

X	MATERIAL	*POST RECOMMENDED
	1.90"x.065" 304 SERIES S.S. TUBE **	56" AND LONGER
	1.90"x.109" 304 SERIES S.S. TUBE **	87" AND LONGER
	1.90"x.145" 304 SERIES S.S. TUBE **	109" AND LONGER
	1.50"x.083" 316 SERIES S.S. TUBE	42" AND LONGER
	1.50"x.120" 316 SERIES S.S. TUBE	56" AND LONGER



7100 Spectrum Lane
 Missoula, Montana 59808
 406.542.9781 * 800.791.8056
 Fax: 406.542.1158
 www.spectrumproducts.com

Submitted By: _____

Signature: _____

Date: _____

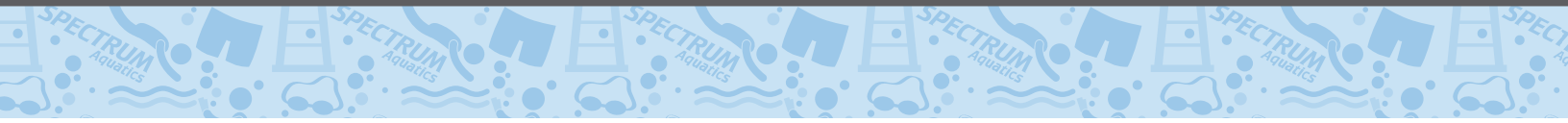

NOTES



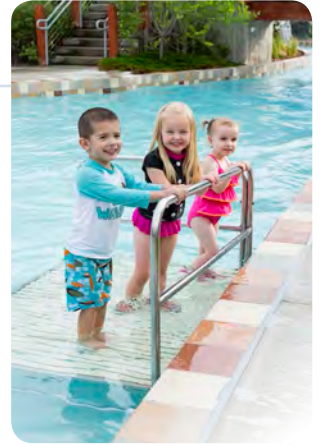

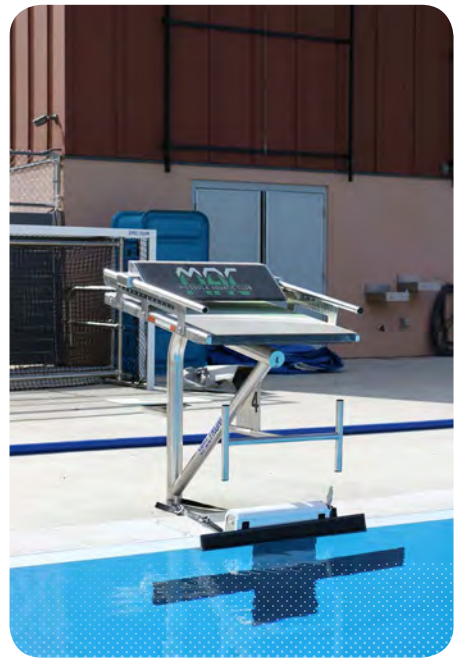
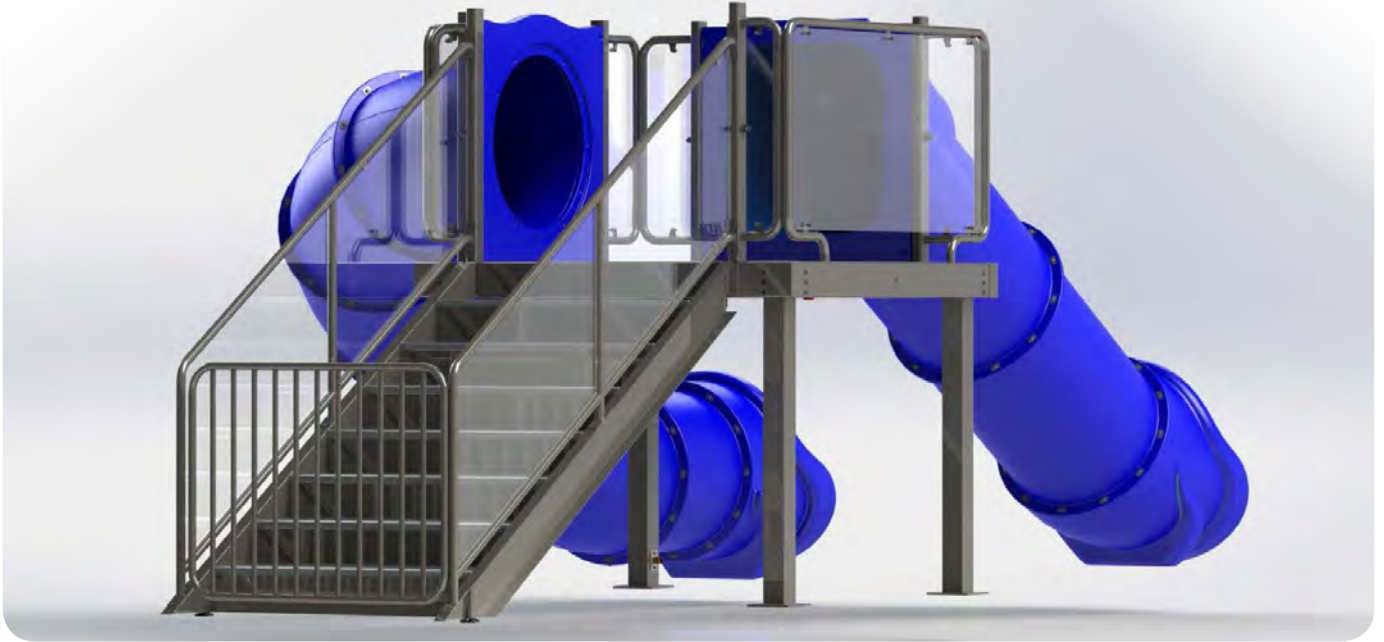

NEW PRODUCTS!

Backstroke Start Device – Page 4
Solarian – Page 18

Elegante’ – Page 19
Ultimate Pool Slides – Page 30



BEN SHAFFER
Recreation Inc.



PARK, PLAYGROUND & STREETScape SOLUTIONS

Serving NJ since 1921

P. O. Box 844
Lake Hopatcong, NJ 07849

1-800-953-2021

sales@benshaffer.com

www.benshaffer.com